

INFORMATION SHEET

T 8210 EN

CERA1000 · Ball Valves with Ceramic Lining



Application



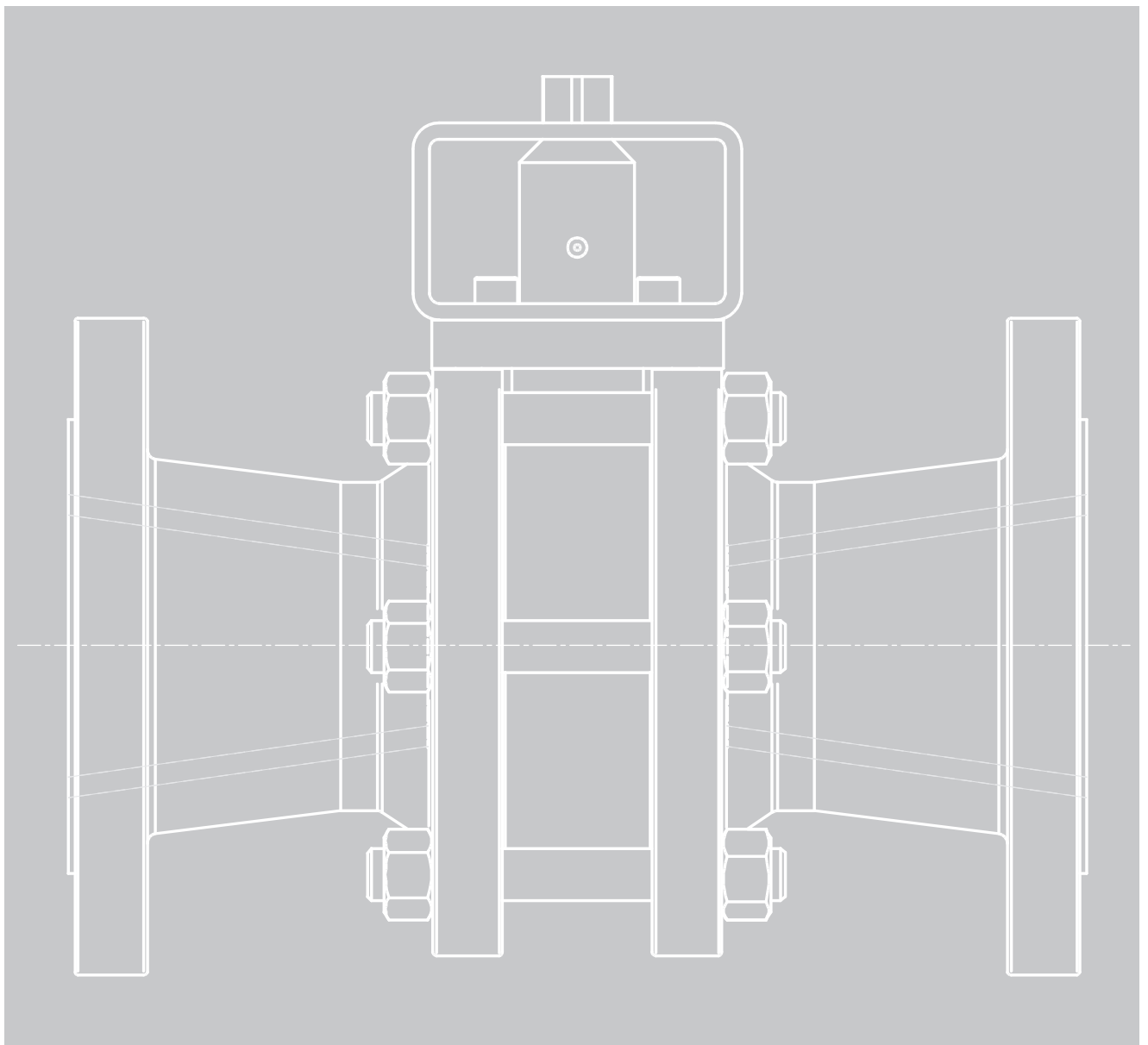

The Series CERA1000 Ceramic-lined Ball Valves are used for on/off or throttling service to meet high requirements concerning resistance to wear, corrosion and high temperatures.





Overview of types

- Standard version; ◦ Special version/option

Customized ball valve versions are also possible to meet special requirements.



Type		KSV	KST	KAT	KAV	
						
Markets	Chemicals and petrochemicals	•	•	•		
	Industrial gases			•		
	Power and energy	•	•	•		
	Oil and gas					
	Food and beverages					
	Pharmaceuticals and biotechnology					
	Metallurgy and mining	•	•	•	•	
	Pulp and paper	•	•	•		
	District energy and building automation					
	Marine equipment					
	Water and wastewater	•	•	•	•	
	General industry	•	•	•	•	
Other markets	•	•	• 7)	• 7)		
Application	On/off	•	•	•	•	
	Throttling	•	•	•	•	
Suitability	Fibrous media					
	Media containing suspended matter					
	Corrosive media	•	•	•	•	
	Highly viscous media					
	Abrasive media	•	•	•	•	
	Seawater					
Oxygen						
Version	DIN	•	•	•	•	
	ANSI	•	•	•	•	
Connecting flange	DIN EN 1092-1	•	•	•	•	
	ASME B16.5	•	•	•	•	
Size	Flange	DN	15 to 300	15 to 300	15 to 300	15 to 300
		NPS	½ to 12	½ to 12	½ to 12	½ to 12
	Middle body	DN	15 to 150	15 to 150	15 to 150	15 to 150
		NPS	½ to 6	½ to 6	½ to 6	½ to 6
Pressure rating	PN	10 to 40 ¹⁾	10 to 40 ¹⁾	10 to 40 ¹⁾	10 to 40 ¹⁾	
	Class	150 and 300 ¹⁾	150 and 300 ¹⁾	150 and 300 ¹⁾	150 and 300 ¹⁾	
Temperature range ⁸⁾ in °C	Standard	-10 to +160	-10 to +180	-10 to +180	-10 to +160	
	Deviation	With FFKM	-	Up to +260	Kalrez [®] 6375: up to +260 Kalrez [®] 4079: up to +310	-
		With Fluoraz [®]	-	-	-	-
Face-to-face dimensions	Acc. to EN 558-1 Series 1, 27	• ²⁾	• ²⁾	• ²⁾	• ²⁾	
	Acc. to ASME/ANSI B16.10/ EN 558-2 Series 37,38, 3	• ²⁾	• ²⁾	• ²⁾	• ²⁾	

	KZT	KGT	KST-HT	KST-XHT	Type
					
			•	•	Chemicals and petrochemicals
	•		•	•	Industrial gases
		•			Energy
					Oil and gas
					Food and beverages
					Pharmaceuticals and biotechnology
	•	•			Metallurgy and mining
		•			Pulp and paper
					District energy and building automation
					Marine equipment
					Water and wastewater
	•	•	•	•	General industry
	•	•	•	•	Other markets
	•	•	•	•	On/off
	•	•	•	•	Throttling
					Fibrous media
					Media containing suspended matter
	•	•	•	•	Corrosive media
					Highly viscous media
	•	•	•	•	Abrasive media
					Seawater
					Oxygen
	•	•	•	•	DIN
	•	•	•	•	ANSI
	•	•	•	•	DIN EN 1092-1
	•	•	•	•	ASME B16.5
	65 to 300	65 to 300	15 to 300	15 to 300	DN
	2½ to 12	2½ to 12	½ to 12	½ to 12	NPS
	65 to 150	65 to 150	15 to 150	15 to 150	DN
	2½ to 6	2½ to 6	½ to 6	½ to 6	NPS
	10 to 40 ¹⁾	10 to 40 ¹⁾	10 to 40 ¹⁾	10 to 40 ¹⁾	PN
	150 and 300 ¹⁾	150 and 300 ¹⁾	150 and 300 ¹⁾	150 and 300 ¹⁾	Class
	-10 to +180	-10 to +180	-10 to +450	-10 to +950	Standard
	-	-	-	-	With FFKM
	Up to +260	Up to +260	-	-	With Fluoraz®
	• ²⁾	• ²⁾	• ²⁾	• ²⁾	Acc. to EN 558-1 Series 1, 27
	• ²⁾	• ²⁾	• ²⁾	• ²⁾	Acc. to ASME/ANSI B16.10/ EN 558-2 Series 37,38, 3

Type	KSV	KST	KAT	KAV	
					
Body	<ul style="list-style-type: none"> • 1.4301/1.4408 ○ P250GH Halar® (DN 125 and larger) 	<ul style="list-style-type: none"> • 1.4301/1.4408 ○ 1.4462, ○ 1.4571, ○ 1.4539, ○ P250GH, ○ 3.7035, ○ PVDF⁹⁾, ○ PP⁹⁾ 	<ul style="list-style-type: none"> • 1.4301/1.4408 ○ 1.4462, ○ 1.4571, ○ 1.4539, ○ P250GH, ○ 3.7035 	<ul style="list-style-type: none"> • 1.4301/1.4408 ○ P250GH Halar®⁶⁾ 	
Seat ring	<ul style="list-style-type: none"> • Al₂O₃ ○ SSiC 	<ul style="list-style-type: none"> • Al₂O₃ ○ SSiC 	<ul style="list-style-type: none"> • Al₂O₃ ○ SSiC 	<ul style="list-style-type: none"> • Al₂O₃ ○ SSiC 	
Ball socket	<ul style="list-style-type: none"> • Al₂O₃ ○ SSiC 	<ul style="list-style-type: none"> • Al₂O₃ ○ SSiC 	<ul style="list-style-type: none"> • Al₂O₃ ○ SSiC 	<ul style="list-style-type: none"> • Al₂O₃ ○ SSiC 	
Ball	<ul style="list-style-type: none"> • ZrO₂ ○ Si₃N₄ 	<ul style="list-style-type: none"> • ZrO₂ ○ Si₃N₄, ○ 1.4112 (58HRC) 	<ul style="list-style-type: none"> • ZrO₂ ○ Si₃N₄, ○ 1.4112 (58HRC) 	<ul style="list-style-type: none"> • ZrO₂ ○ Si₃N₄ 	
Retaining ring	–	–	<ul style="list-style-type: none"> • Al₂O₃ ○ 1.4301/1.4408 	<ul style="list-style-type: none"> • Al₂O₃ 	
Thrust ring (spring)	–	–	<ul style="list-style-type: none"> • 1.4301/1.4408 ○ 1.4462 	<ul style="list-style-type: none"> • 1.4301/1.4408 Halar® 	
Thrust ring (seat)	–	–	<ul style="list-style-type: none"> • 1.4301/1.4408 ○ 1.4462 	<ul style="list-style-type: none"> • 1.4301/1.4408 	
Stuffing box	–	–	–	–	
Packing gland	–	–	–	–	
Shaft	<ul style="list-style-type: none"> • 2.4605 ○ 3.7035, ○ Tantalum 2.5 % tungsten, ○ 1.4539 	<ul style="list-style-type: none"> • 1.4462 ○ 2.4605, ○ 3.7035, ○ Tantalum, ○ 1.4539 	<ul style="list-style-type: none"> • 1.4462 ○ 2.4605, ○ 3.7035, ○ Tantalum, ○ 1.4539 	<ul style="list-style-type: none"> • 2.4605 ○ 3.7035, ○ Tantalum 2.5 % tungsten, ○ 1.4539 	
Connecting flange	<ul style="list-style-type: none"> • P250GH Halar® 	<ul style="list-style-type: none"> • 1.4301/1.4408 ○ 1.4462, ○ 1.4571, ○ 1.4539, ○ P250GH, ○ 3.7035 	<ul style="list-style-type: none"> • 1.4301/1.4408 ○ 1.4462, ○ 1.4571, ○ 1.4539, ○ P250GH, ○ 3.7035 	<ul style="list-style-type: none"> • P250GH Halar® 	
Liner	<ul style="list-style-type: none"> • Al₂O₃ ○ SSiC 	<ul style="list-style-type: none"> • Al₂O₃ ○ SSiC 	<ul style="list-style-type: none"> • Al₂O₃ ○ SSiC 	<ul style="list-style-type: none"> • Al₂O₃ ○ SSiC 	
Compression spring	–	–	<ul style="list-style-type: none"> • 1.4310 	<ul style="list-style-type: none"> • 1.4301/1.4408 	
Trunnion bearing	–	–	–	–	
Bonnet flange	<ul style="list-style-type: none"> • 1.4301/1.4408 	<ul style="list-style-type: none"> • 1.4301/1.4408 ○ 1.4462, ○ 1.4571, ○ 1.4539, ○ P250GH, ○ 3.7035 	<ul style="list-style-type: none"> • 1.4301/1.4408 ○ 1.4462, ○ 1.4571, ○ 1.4539, ○ P250GH, ○ 3.7035 	<ul style="list-style-type: none"> • 1.4301/1.4408 ○ 1.4462, ○ 1.4571, ○ 1.4539, ○ P250GH, ○ 3.7035 	
Seal/packing sets	<ul style="list-style-type: none"> • Type 6 ○ Type 7, 8, 9 	<ul style="list-style-type: none"> • Type 1 ○ Type 2, 3, 4, 5 	<ul style="list-style-type: none"> • Type 1 ○ Type 2, 3, 4, 5 	<ul style="list-style-type: none"> • Type 6 ○ Type 7, 8, 9 	
Packing	–	–	–	–	
Bearing bushing	<ul style="list-style-type: none"> • PTFE 	<ul style="list-style-type: none"> • PTFE 	<ul style="list-style-type: none"> • PTFE 	<ul style="list-style-type: none"> • PTFE 	
Nuts and bolts	<ul style="list-style-type: none"> • A2-/A4-70 	<ul style="list-style-type: none"> • A2-/A4-70 	<ul style="list-style-type: none"> • A2-/A4-70 	<ul style="list-style-type: none"> • A2-/A4-70 	

	KZT	KGT	KST-HT	KST-XHT	Type
					
	<ul style="list-style-type: none"> • 1.4301/1.4408 ○ 1.4462, ○ 1.4571, ○ 1.4539, ○ P250GH, ○ 3.7035 	<ul style="list-style-type: none"> • 1.4301/1.4408 ○ 1.4462, ○ 1.4571, ○ 1.4539, ○ P250GH, ○ 3.7035 	<ul style="list-style-type: none"> • 1.4301/1.4408 ○ 1.4571, ○ P250GH 	<ul style="list-style-type: none"> • 1.4876(H) 	Body
	<ul style="list-style-type: none"> • Al₂O₃ ○ SSiC 	<ul style="list-style-type: none"> • Al₂O₃ ○ SSiC 	<ul style="list-style-type: none"> • SSiC ○ Si₃N₄ 	<ul style="list-style-type: none"> • SSiC ○ Si₃N₄ 	Seat ring
	<ul style="list-style-type: none"> • Al₂O₃ ○ SSiC 	<ul style="list-style-type: none"> • Al₂O₃ ○ SSiC 	<ul style="list-style-type: none"> • SSiC ○ Si₃N₄ 	<ul style="list-style-type: none"> • SSiC ○ Si₃N₄ 	Ball socket
	<ul style="list-style-type: none"> • ZrO₂ ○ Si₃N₄, ○ 1.4112 (58HRC) 	<ul style="list-style-type: none"> • ZrO₂ ○ Si₃N₄, ○ 1.4112 (58HRC) 	<ul style="list-style-type: none"> • Si₃N₄ ○ ZrO₂, ○ 1.4112 (58HRC) 	<ul style="list-style-type: none"> • Si₃N₄ 	Ball
	<ul style="list-style-type: none"> • Al₂O₃ ○ 1.4301/1.4408 	<ul style="list-style-type: none"> • Al₂O₃ ○ 1.4301/1.4408 	–	–	Retaining ring
	<ul style="list-style-type: none"> • 1.4301/1.4408 ○ 1.4462 	<ul style="list-style-type: none"> • 1.4301/1.4408 ○ 1.4462 	–	–	Thrust ring (spring)
	<ul style="list-style-type: none"> • 1.4301/1.4408 ○ 1.4462 	<ul style="list-style-type: none"> • 1.4301/1.4408 ○ 1.4462 	–	–	Thrust ring (seat)
	<ul style="list-style-type: none"> • 1.4301/1.4408 ○ 1.4462, ○ 1.4571, ○ 1.4539, ○ P250GH, ○ 3.7035 	<ul style="list-style-type: none"> • 1.4301/1.4408 ○ 1.4462, ○ 1.4571, ○ 1.4539, ○ P250GH, ○ 3.7035 	<ul style="list-style-type: none"> • 1.4301/1.4408 ○ 1.4571, ○ P250GH 	<ul style="list-style-type: none"> • 1.4876(H) 	Stuffing box
	–	–	<ul style="list-style-type: none"> • 1.4301/1.4408 ○ 1.4571, ○ P250GH 	<ul style="list-style-type: none"> • 1.4571 	Packing gland
	<ul style="list-style-type: none"> • 1.4462 ○ 1.4542 (hardened), ○ 17PH4, ○ 1.4539 	<ul style="list-style-type: none"> • 1.4462 ○ 1.4542 (hardened), ○ 17PH4, ○ 1.4539 	<ul style="list-style-type: none"> • 1.4542 ○ 17PH4 	<ul style="list-style-type: none"> • 1.4876(H) 	Shaft
	<ul style="list-style-type: none"> • 1.4301/1.4408 ○ 1.4462, ○ 1.4571, ○ 1.4539, ○ P250GH, ○ 3.7035 	<ul style="list-style-type: none"> • 1.4301/1.4408 ○ 1.4462, ○ 1.4571, ○ 1.4539, ○ P250GH, ○ 3.7035 	<ul style="list-style-type: none"> • 1.4301/1.4408 ○ 1.4571, ○ P250GH 	<ul style="list-style-type: none"> • 1.4876(H) 	Connecting flange
	<ul style="list-style-type: none"> • Al₂O₃ ○ SSiC 	<ul style="list-style-type: none"> • Al₂O₃ ○ SSiC 	<ul style="list-style-type: none"> • SSiC ○ Si₃N₄ 	<ul style="list-style-type: none"> • SSiC ○ Si₃N₄ 	Liner
	<ul style="list-style-type: none"> • 1.4310 	<ul style="list-style-type: none"> • 1.4310 	–	–	Compression spring
	<ul style="list-style-type: none"> • 1.4301/1.4408 ○ 1.4462, ○ 1.4571, ○ 1.4539, ○ P250GH, ○ 3.7035 	<ul style="list-style-type: none"> • 1.4301/1.4408 ○ 1.4462, ○ 1.4571, ○ 1.4539, ○ P250GH, ○ 3.7035 	–	–	Trunnion bearing
	–	–	–	–	Bonnet flange
	<ul style="list-style-type: none"> • Type 10 ○ Type 11, 12, 13 	<ul style="list-style-type: none"> • Type 10 ○ Type 11, 12, 13 	<ul style="list-style-type: none"> • Graphite 	<ul style="list-style-type: none"> • Graphite 	Seal/packing sets
	–	–	<ul style="list-style-type: none"> • Graphite ○ Packing 	<ul style="list-style-type: none"> • Graphite ○ Packing 	Packing
	<ul style="list-style-type: none"> • PTFE 	<ul style="list-style-type: none"> • PTFE 	<ul style="list-style-type: none"> • Stellite™/graphite 	<ul style="list-style-type: none"> • Stellite™/graphite 	Bearing bushing
	<ul style="list-style-type: none"> • A2-/A4-70 	<ul style="list-style-type: none"> • A2-/A4-70 	<ul style="list-style-type: none"> • A2-/A4-70 ○ 21CrMoV57/24CrMo5 	<ul style="list-style-type: none"> • 1.4876(H) 	Nuts and bolts

Materials

Type		KSV	KST	KAT	KAV	
						
Mounting and seal of closure member	Floating design	•	•	•	–	
	Trunnion design	–	–	–	–	
	Spring-loaded seat ring	Upstream	–	–	•	•
Downstream		–	–	–	–	
Characterized ball	Equal-percentage characteristic	Round	•	•	•	•
		V-shaped	•	•	•	•
Cross-sectional area of flow	Full bore ³⁾	•	•	•	•	
	Reduced bore ⁴⁾	•	•	•	•	
Leakage class	IEC 60534-4	o ¹⁰⁾	o ¹⁰⁾	o ¹⁰⁾	o ¹⁰⁾	
Accessories and special versions	TA Luft ⁵⁾	–	o	o	o	
Connection to mount actuator	DIN EN ISO 5211	•	•	•	•	
Recommended actuator		Type 31 (SAMSON PFEIFFER)	Type 31 (SAMSON PFEIFFER)	Type 31 (SAMSON PFEIFFER)	Type 31 (SAMSON PFEIFFER)	
Suitability/special features		– Alternative to PTFE/PFA-lined valves	– Can be manufactured in all commonly available body materials – To meet special requirements concerning temperature or fugitive emissions	– Can be manufactured in all commonly available body materials – To meet special requirements concerning temperature or fugitive emissions – At low pressure drops and/or slow pressure build-up	– Alternative to PTFE/PFA-lined valves – At low pressure drops and/or slow pressure build-up	
Compliance		CE EAC	CE EAC	CE EAC	CE EAC	

1) Other pressure ratings on request

2) Series 1 and 3 are only to be used in exceptional circumstances and only after consulting SAMSON CERA SYSTEM.

3) The cross-section is **not** restricted when the valve is fully open.

4) The cross-section is restricted when the valve is fully open.

5) Approved up to max. 400 °C







6) DN 125 and larger

7) For example, dyes and pigments, fertilizer, polysilicon, waste incineration, lithium, salt solutions, desulphurization

8) Observe thermal shock resistance (see Fig. 5)

9) Only after consulting SAMSON CERA SYSTEM

10) Leakage class I, IV or V depending on requirements

	KZT	KGT	KST-HT	KST-XHT	Type
					
	–	–	•	•	Floating design
	•	•	–	–	Trunnion design
	•	•	–	–	Upstream
	•	–	–	–	Downstream
	•	•	•	•	Round
	•	•	•	•	V-shaped
	•	•	•	•	Equal-percentage characteristic
	•	•	•	•	Full bore ³⁾
	•	•	•	•	Reduced bore ⁴⁾
	o ¹⁰⁾	o ¹⁰⁾	o ¹⁰⁾	o ¹⁰⁾	IEC 60534-4
	o	o	o	o	TA Luft ⁵⁾
	•	•	•	•	DIN EN ISO 5211
	Type 31 (SAMSON PFEIFFER)	Type 31 (SAMSON PFEIFFER)	Type 31 (SAMSON PFEIFFER)	Type 31 (SAMSON PFEIFFER)	Recommended actuator
	<ul style="list-style-type: none"> – Can be manufactured in all commonly available body materials – To meet special requirements concerning temperature or fugitive emissions – At high pressure drops – Pressure can be applied to both sides 	<ul style="list-style-type: none"> – Can be manufactured in all commonly available body materials – To meet special requirements concerning temperature or fugitive emissions – At high pressure drops – Only seals on one side to avoid dead spaces – With pneumatic conveying system 	<ul style="list-style-type: none"> – Service temperatures up to 450 °C are possible through the use of special body and ceramic materials. 	<ul style="list-style-type: none"> – Service temperatures up to 950 °C are possible through the use of special body and ceramic materials. 	Suitability/special features
					Compliance

Why ceramic valves?

Ceramic-lined valves are preferably used for corrosive media (possibly containing solid matter) or (very) abrasive media. Ceramic linings are particularly suitable to meet high temperature, pressure, abrasion or corrosion requirements where other linings, e.g. made of PTFE or PFA, reach their limits.

Ceramic materials

The following ceramic materials are used for valve linings:

- Alumina (Al_2O_3)
- Zirconium dioxide (ZrO_2)
- Silicon carbide (SSiC)
- Silicon nitride (Si_3N_4)

The benefits and special features of ceramics include:

1. Corrosion resistance

The corrosion resistance of ceramics is significantly superior to other materials. Ceramics are fully resistant to most solvents. In most cases, alkaline solutions do not pose any difficulties. The ceramics used exhibit good resistance properties to most acids up to relatively high temperatures. However, there are various factors that need to be taken into account. For example, all oxide ceramics are not resistant to fluorides. Some ceramics, e.g. Yttria-partially-stabilized zirconia (Y-PSZ), react sensitively to steam, i.e. are hydrothermally unstable. It is essential to be aware that mixtures of reagents usually react differently than when handled separately.

2. Compression and flexural strength

In contrast to metal, the flexural, tensile and compression strength properties of ceramics vary significantly. While the compression strength of almost all dense ceramics is superior to that of metals, more attention must be paid especially to the tensile and flexural strength.

The extremely high compression strength of Al_2O_3 is particularly suitable for the seat of the ball valve.

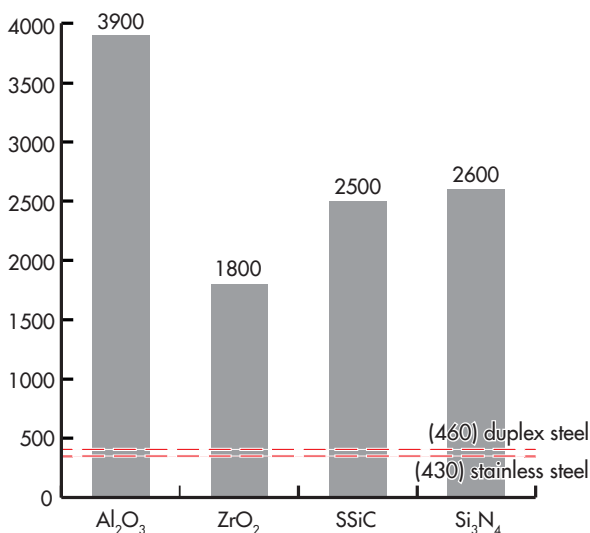

Fig. 1: Compression strength in MPa

The diagrams illustrate the difference between metals and ceramics even though comparing their strength properties is not clear-cut.

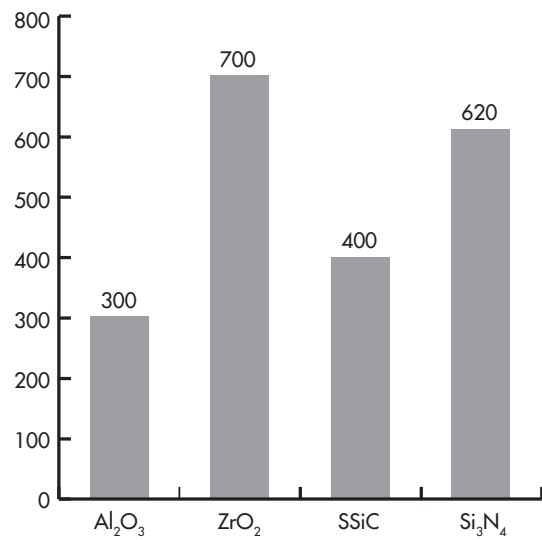

Fig. 2: Flexural strength in MPa

Due to the high torque load, the ball must be made of a material with a high flexural strength. As a result, balls are either made of ZrO_2 or Si_3N_4 .

3. Density

Generally, ceramic valves are lighter than valves made of other materials. For example, ceramics are up to 78 % less dense than carbide metal and up to 60 % less dense than stainless steel.

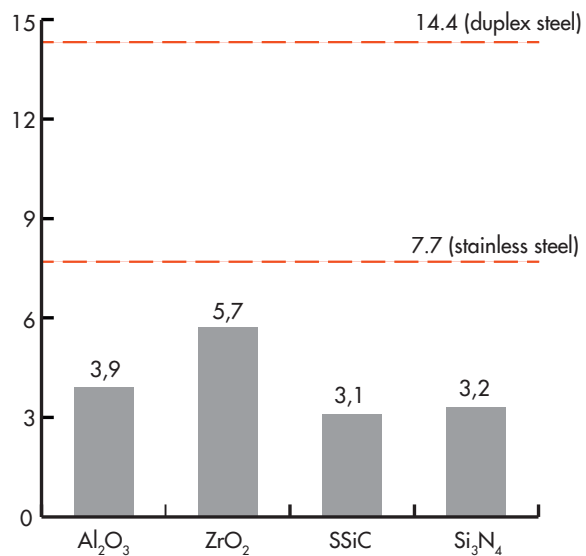

Fig. 3: Density in g/cm^3

4. Hardness and wear resistance

The wear resistance of components considerably depends on the type of stress they are exposed to. Ceramics are much harder and have better wear-resistance properties than metals. Frequently, a combination of different kinds of wear, such as abrasion, high velocity erosion, impact wear and cavitation, arise which ceramic components usually endure much better in comparison to metal components. Direct impact loads must be dealt with on a case-by-case basis.

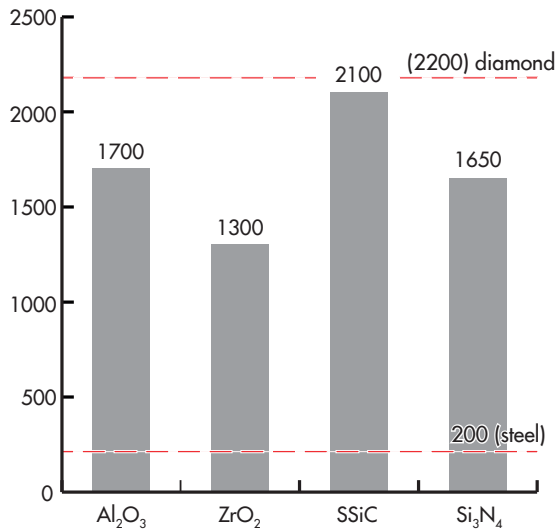

Fig. 4: Vickers hardness H_v in GPa

5. Thermal shock resistance

The thermal shock resistance is more relevant than the maximum service temperature. Ceramic components maintain their shape, material strength and physical properties even at very high temperatures. The thermal shock resistance significantly depends on the shape of the component and not just the material. Simple shapes, such as pipes, are more rugged than parts with greatly varying wall thicknesses.

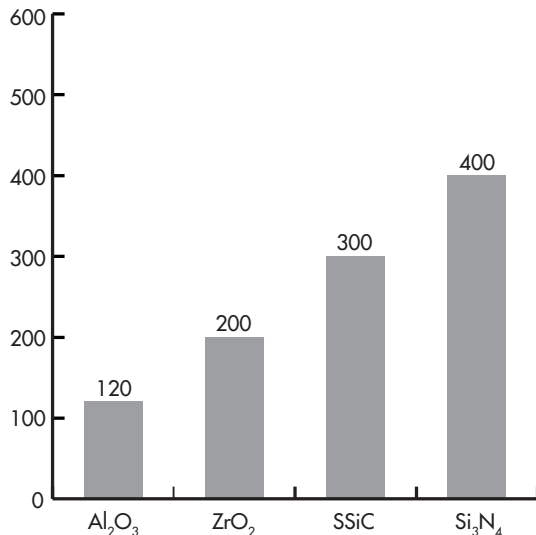

Fig. 5: Thermal shock resistance ΔT in °C

TA Luft packing

The current TA Luft regulations impose stringent fugitive emission limits for valve stem sealing. The TA Luft packing sets cover almost all applications and are suitable for use in new valves or for retrofitting existing valves.

The packing sets guarantee the leakage rates specified in the VDI directives over the entire temperature range. In precise terms, the sealing system must demonstrate a leakage rate of $10^{-4} \frac{\text{mbar} \times \text{l}}{\text{s} \times \text{m}}$ at a temperature of 250 °C or a leakage rate of $10^{-2} \frac{\text{mbar} \times \text{l}}{\text{s} \times \text{m}}$ above this temperature. The packing is live loaded in these applications to ensure continuous compression of the packing. The live loading system is designed and adjusted based on the operating temperature and operating pressure.

Available packing sets to meet TA Luft requirements:

BuraTAL® T1 9650/T1	
Temperature range	-10 to +250 °C
Pressure	40 bar
Chemical resistance	pH value: 1 to 13

BuraTAL® HT 9650/HT	
Temperature range	-200 to +400 °C
Pressure	80 bar
Chemical resistance	pH value: 1 to 13

Technical data

Table 1: K_{VS} and C_V coefficients and associated nominal sizes

Nominal size (flange)		Ball bore	Valve size (middle body)																
			DN 15 NPS ½		DN 25 NPS 1		DN 40 NPS 1½		DN 65 NPS 2½		DN 80 NPS 3		DN 100 NPS 4		DN 125 NPS 5		DN 150 NPS 6		
DN	NPS		K_{VS}	C_V	K_{VS}	C_V	K_{VS}	C_V	K_{VS}	C_V	K_{VS}	C_V	K_{VS}	C_V	K_{VS}	C_V	K_{VS}	C_V	
15	½	V-shaped	12.2	14.2															
		Round	14.6	17.0															
20	¾	V-shaped	14.1	16.5															
		Round	19.1	22.3															
25	1	V-shaped	13.1	15.3	37.3	43.5													
		Round	19.2	22.4	45.9	53.6													
32	1¼	V-shaped	11.5	13.4	41.7	48.7													
		Round	17.3	20.2	62.1	72.5													
40	1½	V-shaped	9.4	11.0	36.5	42.6	89.1	104											
		Round	15.5	18.1	62.4	72.8	127	148											
50	2	V-shaped	9.4	11.0	28.8	33.6	89.4	104											
		Round	14.1	16.5	54.0	63.0	166	193											
65	2½	V-shaped			27.2	31.7	75.5	88.1	202	236									
		Round			46.5	54.3	169	197	342	398									
80	3	V-shaped			26.4	30.8	64.5	75.3	178	207	311	363							
		Round			39.8	46.4	140	163	433	505	529	617							
100	4	V-shaped					61.6	71.9	148	173	248	290	414	483					
		Round					108	125	385	450	670	782	825	962					
125	5	V-shaped					60.0	70.0	138	160	232	271	335	391					
		Round					101	118	285	333	573	668	922	1076	1392	1623			
150	6	V-shaped							132	154	215	250	297	346					
		Round							258	301	482	563	778	907	1711	1996	2031	2369	
200	8	V-shaped											273	319					
		Round											529	617	1458	1700	1917	3091	
250	10	V-shaped																	
		Round													1147	1338	1917	2237	
300	12	V-shaped																	
		Round															1532	1788	
350	14	V-shaped																	
		Round															1380	1610	

Table 2: Torques

Values in table measured on the test bench (with air and water). These values may vary depending on the operating conditions (process medium, temperature).

Table 2.1: Floating ball

Type	Shaft		Ball Material	Valve size (middle body)		Recommended torque in Nm at Δp up to ... bar								Max. perm. torque Nm	Max. differential pressure bar		
	Material	Max. temperature in °C		DN	NPS	1	2	3	4	6	10	16	25			40	
						1	2	3	4	6	10	16	25			40	
KS_	1.4462 or 2.4605 or 1.4539 or 1.4876 or 1.4542	180 or 450 ¹⁾	ZrO ₂ or Si ₃ N ₄	15	½							27	34	40	80		
				25	1								70	85	100	50	
				40	1½								110	135	160	35	
				65	2½					130	155					180	15
				80	3				135	165						190	10
				100	4				170	210						230	8
				125	5			240	290							340	6
			150	6		350	425								500	4	
			1.4112	15	½									35	43	50	160
				25	1									95	110	130	100
				40	1½								140	170		200	35
				65	2½						175	215				250	20
				80	3					240	290					340	12
				100	4				370	450						520	10
125	5					1260	1530						1800	10			
150	6				2100	2550						3000	10				
KA_	1.4462 or 2.4605 or 1.4539 or 1.4876 or 1.4542	180 or 450 ¹⁾	ZrO ₂ or Si ₃ N ₄	15	½						28	34	40	40			
				25	1					70	85		100	25			
				40	1½				115	135			160	13			
				65	2½			130	155			180	7				
				80	3		135	165			190	5					
				100	4	200				230	3						
				125	5	300				350	2						
			150	6	425				500	2							
			1.4112	15	½							35	43	50	40		
				25	1							95	110	130	30		
				40	1½				140	170			200	13			
				65	2½			175	215			250	10				
				80	3		240	290			340	6					
				100	4		370	445			520	5					
125	5			1530				1800	4								
150	6		2550				3000	4									

¹⁾ Depending on model selected

Table 2.2: Trunnion-mounted ball

Type	Shaft		Ball Material	Valve size (middle body)		Recommended torque in Nm at Δp up to ... bar						Max. perm. torque Nm	Max. differential pressure bar
	Material	Max. temperature in °C		DN	NPS	4	6	10	16	25	40		
						4	6	10	16	25	40		
KZ_	1.4462 or 1.4542 or 1.4539	180 or 260 ¹⁾	ZrO ₂ or Si ₃ N ₄	65	2½				220	240		280	25
				80	3			300	380		430	20	
				100	4	390	470		560	16			
				125	5	670	810		950	16			
				150	6	1260	1500		1800	10			
KG_	1.4462 or 1.4542 or 1.4539	180 or 260 ¹⁾	ZrO ₂ or Si ₃ N ₄	65	2½				220	260	280	28	
				80	3			300	380	430	25		
				100	4	390	470	560	20				
				125	5	710	880	950	18				
				150	6	1260	1530	1800	16				

¹⁾ Depending on model selected

Table 3: Dimensions and weights**Table 3.1: Installation height (see DIN EN ISO 5211)**

Valve size (middle body) DN-G		Installation height acc. to flanged version in mm											
DN	NPS	F05-VK14		F07-VK17		F10-VK22		F12-VK27		F14-VK36		F16-VK46	
		H1	H2	H1	H2	H1	H2	H1	H2	H1	H2	H1	H2
15	½	124.0	224.0	124.0	224.0	144.0	244.0	–	–	–	–	–	–
25	1	142.5	242.5	142.5	242.5	162.5	262.5	162.5	262.5	162.5	272.5	–	–
40	1½	158.0	258.0	158.0	258.0	178.0	278.0	178.0	278.0	178.0	288.0	–	–
65	2½	201.5	321.5	201.5	321.5	201.5	321.5	201.5	321.5	201.5	331.5	241.5	361.5
80	3	216.0	336.0	216.0	336.0	216.0	336.0	216.0	336.0	216.0	346.0	256.0	376.0
100	4	232.5	382.5	232.5	382.5	232.5	382.5	232.5	382.5	232.5	392.5	272.5	402.5
125	5	–	–	–	–	253.5	403.5	253.5	403.5	253.5	403.5	273.5	423.5
150	6	–	–	–	–	282.5	–	282.5	–	282.5	472.0	328.5	472.0

Table 3.2: Face-to-face dimensions (see DIN EN 558)

Nominal size (flange) DN-F		Face-to-face dimension L									
DN	NPS	Series 1 ¹⁾	Series 27	Series 37		Series 38		Series 3 ¹⁾		Series 12	
		mm	mm	mm	inch	mm	inch	mm	inch	mm	inch
15	½	130	115	–	–	–	–	–	–	–	–
20	¾	150	120	–	–	–	–	–	–	–	–
25	1	160	125	184	7.25	197	7.75	127	5	–	–
32	1¼	180	130	–	–	–	–	–	–	–	–
40	1½	200	140	222	8.75	235	9.25	165	6½	–	–
50	2	230	150	254	10.0	267	10.5	178	7	–	–
65	2½	290	170	290	11.4	–	–	190	7½	–	–
80	3	310	180	298	11.75	317	12.5	203	8	–	–
100	4	350	190	352	13.88	368	14.5	229	9	–	–
125	5	400	325	–	–	–	–	–	–	356	9
150	6	480	350	451	17.75	473	18.62	–	–	394	14½
200	8	600	400	543	21.38	568	22.38	–	–	457	18
250	10	730	450	673	26.5	708	27.87	–	–	–	–
300	12	850	500	737	29.02	775	30.51	–	–	–	–

¹⁾ Series 1 and 3 are only to be used in exceptional circumstances and only after consulting SAMSON CERA SYSTEM.

Table 3.3: Weights in kg

Nominal size (flange)		Valve size (middle body)															
DN	NPS	DN 15	NPS ½	DN 25	NPS 1	DN 40	NPS 1½	DN 65	NPS 2½	DN 80	NPS 3	DN 100	NPS 4	DN 125	NPS 5	DN 150	NPS 6
		15	½	6.3	–	–	–	–	–	–	–	–	–	–	–	–	–
20	¾	6.3	–	–	–	–	–	–	–	–	–	–	–	–	–	–	–
25	1	6.3	10	–	–	–	–	–	–	–	–	–	–	–	–	–	–
32	1¼	6.9	11	–	–	–	–	–	–	–	–	–	–	–	–	–	–
40	1½	7.3	12	18	–	–	–	–	–	–	–	–	–	–	–	–	–
50	2	7.9	15	18	–	–	–	–	–	–	–	–	–	–	–	–	–
65	2½	–	18	21	38	–	–	–	–	–	–	–	–	–	–	–	–
80	3	–	22	24	39	48	–	–	–	–	–	–	–	–	–	–	–
100	4	–	–	28	40	50	66	–	–	–	–	–	–	–	–	–	–
125	5	–	–	–	44	54	77	99	–	–	–	–	–	–	–	–	–
150	6	–	–	–	51	58	81	110	165	–	–	–	–	–	–	–	–
200	8	–	–	–	–	–	105	140	177	–	–	–	–	–	–	–	–
250	10	–	–	–	–	–	–	165	188	–	–	–	–	–	–	–	–
300	12	–	–	–	–	–	–	–	233	–	–	–	–	–	–	–	–
350	14	–	–	–	–	–	–	–	289	–	–	–	–	–	–	–	–

Dimensional drawings

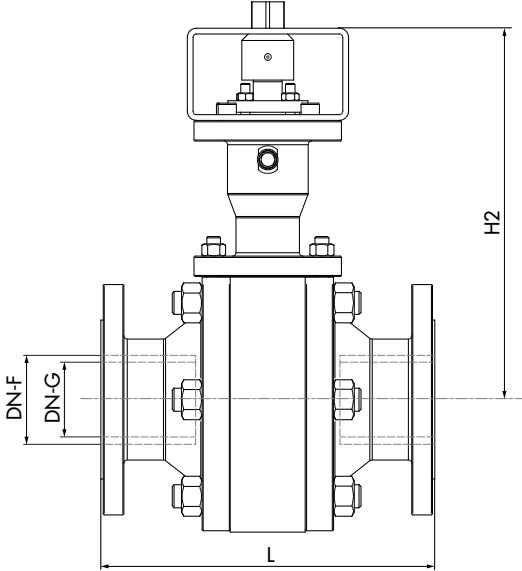
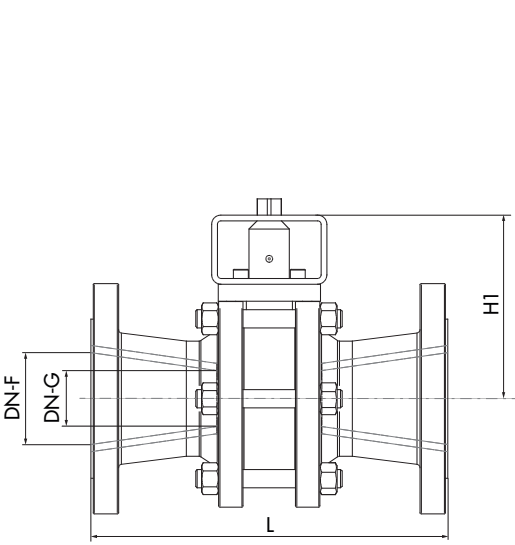

Selection and ordering

Code system

Type	K	x	x	-	x	x	x	-	x	x
Ball valve	K									
Floating ball	S									
Spring-loaded seat	A									
Trunnion-mounted ball, bidirectional sealing	C									
Version for granulate, upstream seat sealing	G									
Full wear protection	V									
Partial wear protection	T									
Very high temperature (up to 950 °C)					X	H	T			
High temperature (up to 450 °C)						H	T			
TA Luft									T	A

Ordering text

Criteria	Value
Nominal size (flange)	DN/NPS ...
Valve size (middle body)	DN/NPS ...
Pressure rating	PN ...
Face-to-face dimension	Series ...
Flanges	
Temperature range	
Materials	See Overview of types on page 2.
Characterized ball	Round/V-shaped
Process medium	
Max. flow rate	in kg/h or m ³ /h
Pressure	p1 and p2 in bar
Required leakage class	
Industrial sector	