

Electropneumatic Ex d Positioner Type 3731-3



With HART[®] communication



Fig. 1 · Type 3731-3

Mounting and Operating Instructions

EB 8387-3 EN

Firmware version 1.3x
Edition November 2005



Contents	Page
1	Design and principle of operation 6
1.1	Communication 7
1.2	Technical data 8
2	Attachment to the control valve – Mounting parts and accessories 10
2.1	Direct attachment 14
2.1.1	Type 3277-5 Actuator 14
2.1.2	Type 3277 Actuator 16
2.2	Attachment according to IEC 60534-6 18
2.3	Attachment to Type 3510 Micro-flow Valve. 20
2.4	Attachment to rotary actuators 22
2.5	Reversing amplifier for double-acting actuators 24
3	Connections 26
3.1	Pneumatic connections 26
3.1.1	Signal pressure gauges 26
3.1.2	Supply pressure 26
3.2	Electrical connections 28
3.2.1	Establishing communication 30
4	Operation 32
4.1	Enabling and selecting parameters 32
4.2	Operating modes 34
4.2.1	Automatic and manual operating modes 34
4.2.2	SAFE – Fail-safe position 35
5	Start-up – Settings 36
5.1	Adapting the display 36
5.2	Limiting the signal pressure 36
5.3	Checking the operating range of the positioner 37
5.4	Determining the fail-safe position 37
5.5	Positioner initialization 39
5.5.1	Initialization modes 40
5.6	Fault/failure 48
5.7	Zero calibration 49
5.8	Reset to default values 49
5.9	Start-up via local interface (SSP) 50
5.10	Start-up over HART® communication 50
6	Status and diagnostic alarms 51
6.1	Standard EXPERT diagnostics 51

6.2	Extended EXPERT+ diagnostics	51
6.3	Classification of the status alarms and the condensed status	52
7	Maintenance	54
8	Servicing explosion-protected devices	54
9	Code list	55
10	Setting with TROVIS-VIEW software – Parameter list	72
10.1	General	72
10.2	Starting TROVIS-VIEW and performing basic settings	73
10.3	Setting the parameters.	76
11	Parameter list	77
12	Dimensions in mm	94
	Test certificates	95

General safety instructions



- ▶ *The positioner may only be assembled, started up or operated by trained and experienced personnel familiar with the product. According to these mounting and operating instructions, trained personnel is referred to as individuals who are able to judge the work they are assigned to and recognize possible dangers due to their specialized training, their knowledge and experience as well as their knowledge of the relevant standards.*
 - ▶ *Explosion-protected versions of this positioner may only be operated by personnel who have undergone special training or instructions or who are authorized to work on explosion-protected devices in hazardous areas. Refer to section 8.*
 - ▶ *Any hazards that could be caused by the process medium, the operating pressure, the signal pressure or by moving parts of the control valve are to be prevented by means of the appropriate measures.*
 - ▶ *If inadmissible motions or forces are produced in the actuator as a result of the supply pressure level, it must be restricted by means of a suitable supply pressure reducing station.
Do not operate the positioner with the back of the positioner/vent opening facing upwards. The vent opening must not be sealed when the positioner is installed on site.*
 - ▶ *Proper shipping and appropriate storage are assumed.*
 - ▶ **Note!** *The device with a CE marking fulfils the requirements of the Directives 94/9/EC (ATEX) and 89/336/EEC (EMC).
The declaration of conformity is available on request.*
-

Article code	Type 3731-3	X	X	X	X	X	X	0	0	0	0	0	X	X
Explosion protection														
⊕ II 2 G EEx d IIC T6/II 2 G EEx de IIC T6 acc. to ATEX		2	1											
EEx d IIC T6 acc. to FM/CSA		2	3											
Optional additional equipment:														
Position transmitter				0	1									
Forced venting				0	5									
Binary output (NAMUR/PLC)				0	6									
EXPERT diagnostics							1							
EXPERT+ diagnostics							2							
Electrical threaded connection	M20x1.5 ½ NPT							1 2						
Special applications														
None													0	
Device compatible with paint													1	
Special versions	None													000

1 Design and principle of operation

The electropneumatic Ex d positioner is mounted to pneumatic control valves and is used to assign the valve position (controlled variable x) to the control signal (reference variable w). The DC control signal received from a control unit is compared to the travel or rotational angle of the control valve and the corresponding signal pressure (output variable y) is issued.

The positioner is designed depending on the corresponding accessories for direct attachment to Type 3277 Actuators or for attachment to actuators according to IEC 60534-6 (NAMUR).

Additionally, a coupling wheel included in the accessories is required to transfer the rotary motion for rotary actuators according to VDI/VDE 3845.

Springless rotary actuators require a reversing amplifier included in the accessories to permit the powered operation in either direction.

The positioner basically consists of a travel sensor system that functions proportional to resistance, an analog i/p module with downstream booster as well as the electronic unit with a microcontroller. All parts are enclosed in an Ex d housing. The electrical cables are connected over a separate terminal compartment which also has Ex d protection.

The position of the valve is transmitted as linear travel motion or angle of rotation to the travel sensor (2) and to an analog PD controller (3). Simultaneously, an A/D converter (4) transmits the position of the valve

to the microcontroller (5). The PD controller compares the actual value with the 4 to 20 mA DC control signal issued by the control unit.

In case of a system deviation, the operation of the i/p converter (6) is changed so that the actuator (1) is filled or vented via the downstream air capacity booster (7). This causes the closure member of the control valve to move to the position determined by the reference variable.

The pneumatic air capacity booster (7) and the pressure regulator (8) are provided with supply air. An intermediate flow regulator (9) with fixed settings is used to purge the positioner and also guarantees trouble-free operation of the pneumatic booster. The output signal pressure supplied by the booster can be limited over the software.

Serial interface

The positioner is equipped with an interface to allow the SAMSON TROVIS-VIEW Configuration and Operator Interface software to transmit data and parameters over a serial interface adapter from the RS-232 interface of a computer to the positioner.

Options

Forced venting: If there is no operating voltage at the corresponding terminals, the i/p module is not actuated. The positioner cannot operate anymore and the control valve moves to the fail-safe position determined by the actuator, independent of the reference variable.

Binary contact: The positioner has three internal binary signals which can be analyzed over the A/B/C terminals. Two of these signals are assigned to the valve end positions

1.2 Technical data

Positioner	
Nominal travel, adjustable	Direct attachment to Type 3277: 3.6 to 30 mm, attachment acc. to IEC 60534-6: 3.6 to 200 mm or 24° to 100° opening angle for rotary actuators
Travel range	Adjustable within the nominal travel/nominal angle, max. ratio 1 : 5
Reference variable w	Signal range 4 to 20 mA, 2-wire unit, reverse polarity protection, min. span 4 mA, static destruction limit 40 V, internal current limit 60 mA
Minimum current	3.6 mA for display, 3.8 mA for operation Load impedance $\leq 9 \text{ V}$ corresponding to $450 \text{ }\Omega$ at 20 mA
Supply air	Supply pressure from 1.4 to 6 bar (20 to 90 psi), Air quality acc. to ISO 8573-1 (edition 2004): Max. particle size and density: Class 4 Oil content: Class 3, pressure dew point: Class 3 or at least 10 K beneath the lowest ambient temperature to be expected
Signal pressure (output)	0 bar up to supply pressure, limitable to 1.4/2.4/3.7 ± 0.2 bar via software
Characteristic, user-defined adjustable over operating software	Linear/equal percentage/reverse equal percentage/butterfly valve linear/ butterfly valve eq. percentage/rotary plug valve linear/rotary plug valve eq. percentage/segmented ball valve linear/segmented ball valve eq.percentage Deviation from terminal-based conformity $\leq 1 \%$
Hysteresis	$\leq 0.3 \%$
Sensitivity	$\leq 0.1 \%$
Transit time	Separately adjustable up to 240 seconds for supply air and exhaust air
Direction of action	Reversible
Air consumption, steady state	Independent from supply pressure approx. $110 \text{ l}_n/\text{h}$
Air delivery Actuator pressurized Actuator vented	At $\Delta p = 6 \text{ bar}$: $\geq 8.5 \text{ m}_n^3/\text{h}$, at $\Delta p = 1.4 \text{ bar}$: $3.0 \text{ m}_n^3/\text{h}$ $K_{V\max}(20 \text{ }^\circ\text{C}) = 0.09$ at $\Delta p = 6 \text{ bar}$: $\leq 14.0 \text{ m}_n^3/\text{h}$, at $\Delta p = 1.4 \text{ bar}$: $4.5 \text{ m}_n^3/\text{h}$ $K_{V\max}(20 \text{ }^\circ\text{C}) = 0.15$
Permissible ambient temperature	-40 to +80 °C The limits specified in the EC Type Examination Certificate additionally apply for explosion-protected devices.
Influences	Temperature: $\leq 0.2 \%$ /10 K Supply air: None Vibration: $\leq 0.25 \%$ up to 2000 Hz and 4 g acc. to IEC 770
Degree of protection	IP 66
Electromagnetic compatibility	Complying with EN 61000-6-2, EN 61000-6-3 and NAMUR Recommendation NE 21
Explosion protection	⊕ II 2 G EEx d IIC T6 / II 2 G EEx de IIC T6 acc. to ATEX EEx d IIC T6 acc. to FM/CSA

Optional binary output Software limit switch, galvanically isolated, optionally NAMUR EN 60947-5-6 or PLC or fault alarm output		
Signal status	Terminals B-C Switching output AC/DC (PLC)	Terminals A-B
	Conductive/remaining voltage < 1.7 V	Non-conducting/ ≥ 2.1 mA
	Non-conducting/high resist. $I < 100 \mu\text{A}$	Conductive/ ≤ 1.2 mA
Operating voltage	Switch. capacity: 40 V DC/28 V/AC 0.3 A Static destr. limit: 45 V DC/32 V/AC 0.4 A	Only for connection to signal converter acc. to EN 60 957-5-6
Optional forced venting , galvanically isolated		
Input	0 to 40 V DC/ 0 to 28 V AC, static destruction limit 45 V DC/ 32 V AC, input resistance $\geq 7 \text{ k}\Omega$	
Signal	Fail-safe position when input voltage ≤ 3 V	Normal operation when input voltage > 5 V
Optional analog position transmitter	Two-wire transmitter	
Supply voltage	11 to 35 V DC, reverse polarity protection, static destruction limit 45 V	
Output signal	4 to 20 mA	
Direction of action	Reversible	
Operating range	-1.25 to 103 % of the travel range, corresponding to 3.8 to 20.5 mA, optionally also for fault alarm over 2.4 or 21.6 mA acc. to NAMUR Recommendation NE 43	
Characteristic	Linear	
Hysteresis and HF influence	Same as positioner	
Other influences	Same as positioner	
Fault alarm	Can be issued with current signal 2.4 mA or 21.6 mA	
Materials		
Housing: Die-cast aluminum EN AC-AL-Si10Mg(Fe) acc. to DIN EN 1706, chromated and plastic coated, External parts: Stainless steel 1.4301/1.4305/1.4310		
Weight	Approx. 2.5 kg	
Communication (local)	SAMSON SSP interface and serial interface adapter	
Software requirements	TROVIS-VIEW with database module 3731-3	
Communication (HART)	HART® field communication protocol	
Software requirements (HART)	For handheld communicator: device description for 3731-3, For PC: DTM file acc. to Specification 1.2, suitable for integrating the positioner in frame applications that supports the FDT/DTM concept (e.g. PACTware); other integration options (e.g. AMS, PDM) available.	

2 Attachment to the control valve – Mounting parts and accessories

The positioner can be attached either directly to a SAMSON Type 3277 Actuator or according to IEC 60534-6 (NAMUR) to control valves with cast yokes or rod-type yokes as well as to rotary actuators according to VDI/VDE 3845.

For attachment to the various actuators, corresponding mounting parts and accessories are required. These are listed with their order numbers in Tables 1 to 5.

On mounting the positioner, use the assignment between the lever and pin position specified in the travel tables opposite.

The travels show the maximum setting range at the positioner. The actual travel at the valve is additionally restricted by the fail-safe position selected and the required actuator spring compression.

The positioner is standard equipped with the lever **M** (pin position **35**).

Note!

If the standard mounted lever M (pin position 35) is replaced, the newly mounted lever must be moved once all the way as far as it will go in both directions to adapt it to the internal measuring lever.

Note!

A signal pressure restriction must be inserted into the positioner when actuators with less than 240 cm² diaphragm area are used (see Table 6 on page 13).

The positioner is fitted with pneumatic connections with 1/4 NPT threads. In case, G 1/4 threaded connections are required, the connecting plate (6) included in the accessories must be attached.

Travel table for direct attachment to Type 3277 Actuators								
Type 3277-5 and 3277 Actuator	Actuator size	Rated travel	Setting range of positioner		Required lever	Assigned pin position		
	cm ²	mm	Min.	Travel			Max.	
	120	7.5	5.0		25.0	M	25	
	120/240/350	15	7.0		35.4	M	35	
700	30	10.0		50.0	M	50		
Travel table for attachment acc. to IEC 60534-6 (NAMUR)								
SAMSON valves			Other valves/actuators			Required lever	Assigned pin position	
Type 3271 Actuator1	cm ²	Rat. travel mm	Min.	Travel	Max.			
	60 and 120 with 3510 valve	7.5	3.6		17.7	S	17	
	120	7.5	5.0		25.0	M	25	
	120/240/350	15	7.0		35.4	M	35	
	700/1400/2800	15 and 30/30	10.0		50.0	M	50	
	1400/2800	60	14.0		70.7	L	70	
	1400/2800	60	20.0		100.0	L	100	
	1400/2800	120	40.0		200.0	XL	200	
Rotary actuators					Opening angle 24 to 110°		M	90°

Attachment to the control valve – Mounting parts and accessories

Table 1		Direct attachment	Order no.	
Mounting parts	For actuators with 120 cm ² effective diaphragm area, see Fig. 3		1400-7452	
Accessories for the actuator	Switchover plate (old) for Actuator Type 3277-5xxxxx.00 (old)		1400-6819	
	Switchover plate new for Actuator Type 3277-5xxxxx.01 (new)		1400-6822	
	Connecting plate for additional attachment of a solenoid valve G 1/8		1400-6820	
	Connecting plate (old) for Actuator Type 3277-5xxxxx.00 (old) 1/8 NPT		1400-6821	
	Connecting plate new for Actuator Type 3277-5xxxxx.01 (new)		1400-6823	
<i>Note: Only new switchover and connecting plates can be used with new actuators (Index 01). Old and new plates are not interchangeable.</i>				
Accessories for the positioner	Connecting plate (6)	G ¼: 1400-7461		
	or pressure gauge bracket (7)	G ¼: 1400-7458	¼ NPT: 1400-7459	
	Pressure gauge mounting kit (8) (output/supply)	St. st./Bs: 1400-6950	St. st./St. st.: 1400-6951	
Table 2		Direct attachment		
Accessories	Mounting parts for actuators with 240, 350 and 700 cm ² , see Fig. 4		1400-7453	
	Required piping with screw fittings for "Actuator stem retracts" or when the top diaphragm chamber is filled with air	cm ²	Steel	Stainless steel
		240	1400-6444	1400-6445
		350	1400-6446	1400-6447
		700	1400-6448	1400-6449
Connection block with seals and screw		G ¼: 1400-8811	¼ NPT: 1400-8812	
Pressure gauge mounting kit (output and supply)		St.st./Bs: 1400-6950	St.st./St.st.: 1400-6951	

Table 3 Attachment to NAMUR ribs or control valves with rod-type yokes (rod diameter Ø 35 mm or smaller) according to IEC 60534-6, see Fig. 5			
Travel in mm	Lever	For actuators	Order no.
7.5	S	Type 3271-5 Actuator w. 60/120 cm ² on Type 3510 Valve	1400-7457
5 to 50	Without (lever M on standard model)	Actuators from other manufacturers and Type 3271 with 120 to 700 cm ²	1400-7454
14 to 100	L	Actuators f. other manufacturers and Type 3271 w. 1400 cm ²	1400-7455
40 to 200	XL	Actuators from other manufacturers and Type 3271 with 1400/2800 cm ² , 120 mm travel	1400-7456
30 or 60	L	Type 3271 Actuator with 1400cm ² (120 mm travel), 2800 cm ² (30 or 60 mm travel)	1400-7466
Accessories	Connecting plate		G ¼: 1400-7461
	or pressure gauge bracket (7)		G ¼: 1400-7458 ¼ NPT: 1400-7459
	Pressure gauge mounting kit (output/supply)		St.st./Bs: 1400-6950 St.st./St.st.: 1400-6951
Table 4 Attachment to Type 3510 Micro-flow Valves, see Fig. 6			Order no.
Actuator cm 260 /120	Attachment to lever S		1400-7457
Accessories	Connecting plate (6)		G ¼: 1400-7461
	or pressure gauge bracket (7)		G ¼: 1400-7458 ¼ NPT: 1400-7459
	Pressure gauge mounting kit (output/supply)		St.st./Bs: 1400-6950 St.st./St.st.: 1400-6951
Table 5 Attachment to rotary actuators (VDI/VDE 3845 for all sizes of fixing level 2) see Figs. 7 and 8			
Mounting parts	Attachment acc. to VDI/VDE 3845 Attachment for SAMSON Type 3278 (also for VETEC Type S160 and Type R) Attachment for Camflex II		1400-9244 1400-9245 1400-9120
Accessories	Connecting plate		G ¼: 1400-7461
	or pressure gauge bracket (7)		G ¼: 1400-7458 ¼ NPT: 1400-7459
	Pressure gauge mounting kit (output/supply)		St.st./Bs: 1400-6950 St.st./St.st.: 1400-6951
Table 6 General accessories			
Accessories	Pneumatic reversing amplifier for double-acting actuators	G ¼ ¼ NPT	1079-1118 1079-1119
	Signal pressure restrictions (screw-in and brass restrictions)		1400-6964

2.1 Direct attachment

2.1.1 Type 3277-5 Actuator

Refer to Table 1 on page 12 for the required mounting parts as well as the accessories with their order numbers as well as to the travel table on page 11.

Actuator with 120 cm²

Depending on the type of positioner attachment, the signal pressure is routed either left or right of the yoke through a bore to the actuator diaphragm. Depending on the fail-safe action of the actuator "Actuator stem extends" or "Actuator stem retracts" (valve closes or opens if the supply air fails), the switchover plate (9) must first be attached to the actuator yoke. Align the switchover plate with the corresponding symbol for left or right attachment according to the marking (view looking onto the switchover plate).

1. If applicable, mount pressure gauge bracket (7) with pressure gauges or, in case G ¼ threaded connections are required, the connecting plate (6), making sure both seal rings (6.1) are seated properly.
2. Remove screw plug (4) on the back of the positioner and seal the signal pressure output "Output 38" (or on the pressure gauge bracket (7) or on the connecting plate (6)) with the stopper (5) included in the accessories.
3. Place follower clamp (3) on the actuator stem, align and screw tight so that the mounting screw is located in the groove of the actuator stem.
4. Press the brass restriction 1400-6964 from the accessories into the seal of the signal pressure input at the actuator yoke.
5. Mount cover plate (10) with narrow side of the cut-out opening (Fig. 3, on the left) pointing towards the signal pressure connection. Make sure that the bonded gasket (14) points towards the actuator yoke.
6. **15 mm travel:** Keep the follower pin (2) at lever **M** (1) on the back of the positioner in the pin position **35** (delivered state).
7.5 mm travel: Remove the follower pin (2) from the pin position **35**, reposition it in the bore for pin position **25** and screw tight.
7. Insert formed seal (15) into the groove of the positioner housing, pressing the four retaining rings over the housing screws and both fittings into the housing recesses.
8. Thread the bias spring (17) through the crosspiece underneath the lever (1) and push into the hole in the housing. Push the lever (1) until it engages into place. Place positioner on the cover plate (10) and fasten it using the three fixing screws.
Check whether the follower pin (2) is resting on the top of the follower clamp (3). The lever (1) must rest on the follower clamp with spring force.
On mounting, make sure that the seal ring (10.1) is inserted in the borehole of the cover plate.

9. Mount cover (11) on the other side. Make sure that the vent plug points downwards when the control valve is installed to allow any condensed water that collects to drain off.

Note!

If a solenoid valve or similar is mounted in addition to the positioner on 120 cm² actuators, do not remove the screw plug (4) at the back of the positioner. In this case, the signal pressure must be routed from the signal pressure output marked "output" to the actuator using the necessary connecting plate (Table 1). The switchover plate (9) is then not used. The connection for the signal pressure output must be fitted with the screw-in restriction 1400-6964 from the accessories.

2.1.2 Type 3277 Actuator

Refer to Table 2 on page 12 for the required mounting parts and the accessories with their order numbers as well as to the travel table on page 11.

Actuators with 240 to 700 cm²

The positioner can be mounted either on the left or on the right side of the yoke. The signal pressure is routed to the actuator over the connection block (12), for actuators with fail-safe action "Actuator stem extends" internally through a bore in the valve yoke and for "Actuator stem retracts" through external piping.

1. Place follower clamp (3) on the actuator stem, align and screw tight so that the mounting screw is located in the groove of the actuator stem.
2. Mount cover plate (10) with narrow side of the cut-out opening (Fig. 4, on the left) pointing towards the signal pressure connection. Make sure that the bonded gasket (14) points towards the actuator yoke.
3. For actuators with 700 cm², remove the follower pin (2) at lever **M** (1) on the back of the positioner from pin position **35**, reposition it in the bore for pin position **50** and screw tight.
For actuators 240 and 350 cm² with 15 mm travel, the follower pin (2) remains in pin position **35**.
4. Insert formed seal (15) into the groove of the positioner housing, pressing the four retaining rings over the housing screws and both fittings into the housing recesses.
5. Thread the bias spring (17) through the crosspiece underneath the lever (1) and push into the hole in the housing. Push the lever (1) until it engages into place. Place positioner on the cover plate (10) and fasten it using the three fixing screws.
Check whether the follower pin (2) is resting on the top of the follower clamp (3). The lever (1) must rest on the follower clamp with spring force.
6. Make sure that the tip of the gasket (16) projecting from the side of the connection block (12) is positioned above the

actuator symbol that corresponds with the actuator with fail-safe action "Actuator stem extends" or "Actuator stem retracts." If necessary, remove the three

fixing screws and the cover. Then reposition the gasket (16) turned by 180°. The previous version of the connection block (Fig. 4, bottom) requires the switch

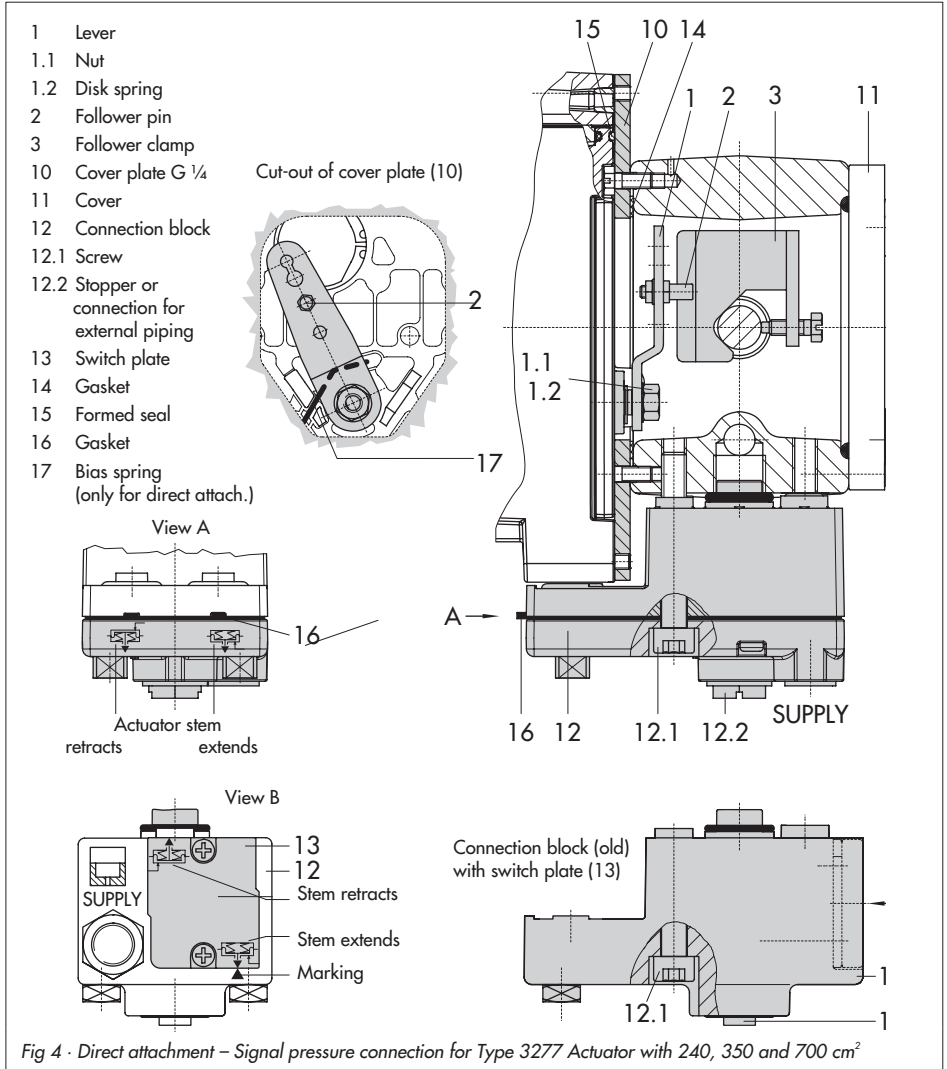

plate (13) to be turned such that the corresponding actuator symbol points to the marking.

- Place the connection block (12) with the associated seal rings against the positioner and the actuator yoke. Screw it tight using the fixing screw (12.1). For actuators with fail-safe action "Actuator stem retracts", additionally remove the stopper (12.2) and fit on the external signal pressure piping.
- Mount cover (11) on the other side. Make sure that the vent plug points to the back when the control valve is installed to allow any condensed water that collects to drain off.

2.2 Attachment according to IEC 60534-6

The positioner is attached to the control valve with a NAMUR bracket (10). Refer to Table 3 on page 13 for the required mounting parts and the accessories with their order numbers as well as to the travel table on page 11.

- Screw the two bolts (14) to the bracket (9.1) of the stem connector (9), place the follower plate (3) on top and use the screws (14.1) to tighten.

Actuator size 2800 cm² and 1400 cm² (120 mm travel):

For a travel of 60 mm or smaller, screw the longer follower plate (3.1) directly to the stem connector (9). For a travel exceeding 60 mm, mount the bracket (16) first and

then the follower plate (3) to the bracket together with the bolts (14) and screws (14.1).

- Mount NAMUR bracket (10) to the control valve as follows:
For attachment to the NAMUR rib, use an M8 screw (11), washer and toothed lock washer directly in the yoke bore. For attachment to valves with rod-type yokes, use two U-bolts (15) around the yoke.
Align the NAMUR bracket (10) in such a way that the slot of the follower plate (3) is centrally aligned with the NAMUR bracket at mid valve travel.
- If applicable, mount pressure gauge bracket (7) with pressure gauges or, in case G 1/4 threaded connections are required, the connecting plate (6), making sure both seal rings (6.1) are seated properly.
Note! Fit screw-in restriction (Table 6) into output when actuators with diaphragm areas smaller than 240 cm² are used.
- Select required lever size (1) **M**, **L** or **XL** and pin position according to the actuator size and valve travels listed in the table on page 11.
Should you require a pin position other than position **35** with the standard installed lever **M**, or require a lever size **L** or **XL**, proceed as follows:
- Screw the follower pin (2) in the assigned lever bore (pin position) as listed in the table. Only use the longer follower pin (2) included in the mounting kit.

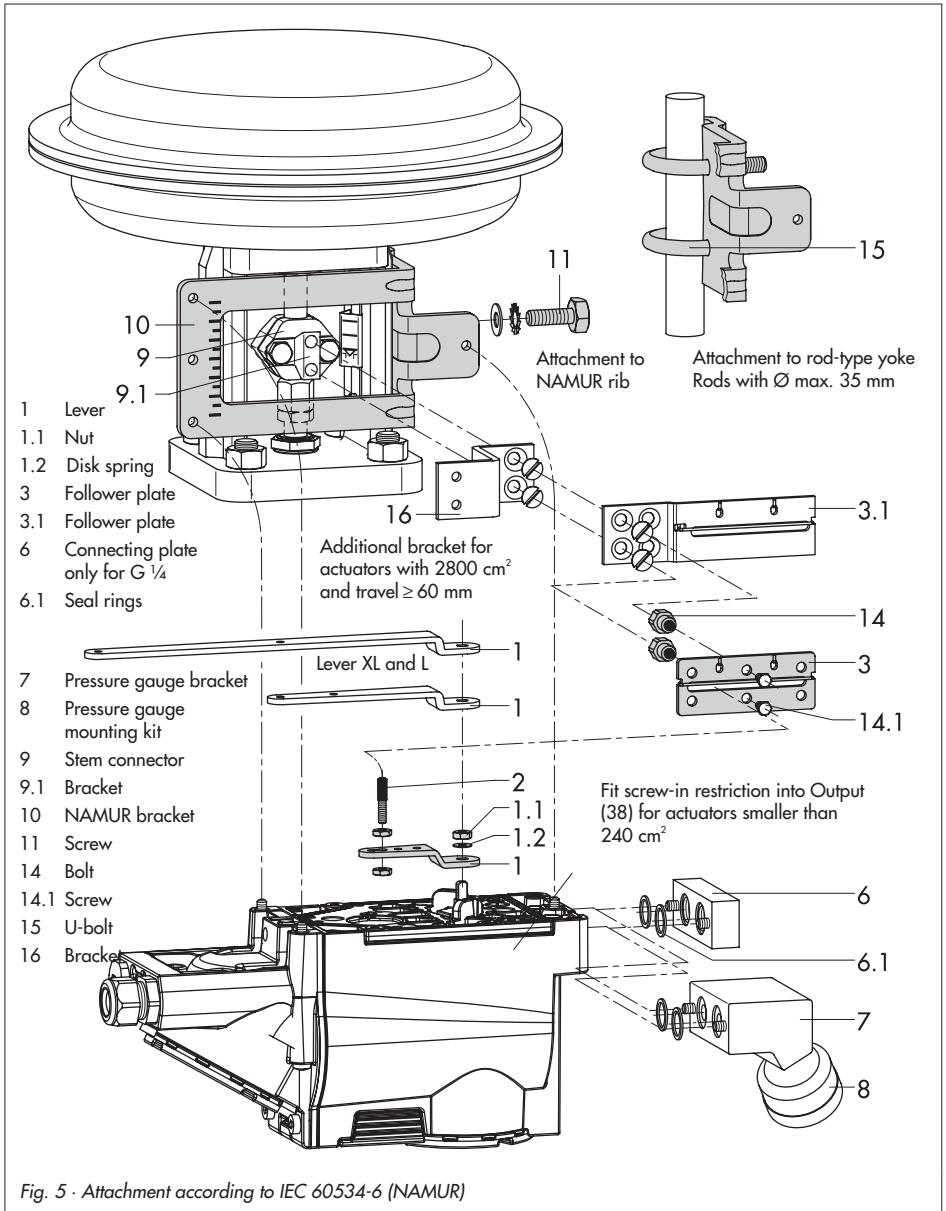

6. Place lever (1) on the positioner shaft and screw tight using the disk spring (1.2) and nut (1.1).

Note!

If you have mounted a new lever (1), you must move it once all the way as far as it will go in both directions.

7. Place positioner on the NAMUR bracket in such a manner that the follower pin (2) rests in the slot of the follower plate (3, 3.1). Adjust the lever (1) correspondingly.
Screw the positioner to the NAMUR bracket using three fixing screws.

2.3 Attachment to Type 3510 Micro-flow Valve

The positioner is attached to the valve yoke using a bracket.

Refer to Table 4 on page 13 for the required mounting parts and the accessories with their order numbers as well as to the travel table on page 11.

1. Place clamp (3) on the valve stem connector, align at a right angle and screw tight.
2. Screw bracket (10) to the valve yoke using two screws (11).
3. If applicable, mount pressure gauge bracket (7) with pressure gauges or, in case G ¼ threaded connections are required, the connecting plate (6), making sure both seal rings (6.1) are seated properly.
4. Fit screw-in restriction (Table 6) into the signal pressure output of the positioner (or output of the pressure gauge bracket or connecting plate).
5. Unscrew the standard installed lever **M** (1) including follower pin (2) from the positioner shaft.
6. Take lever **S** (1) and screw follower pin (2) in the bore for pin position **17**.
7. Place lever **S** on the positioner shaft and screw tight using the disk spring (1.2) and nut (1.1).
Move lever once all the way as far as it will go in both directions.

8. Place positioner on the bracket (10) in such a manner that the follower pin slides into the groove of the clamp (3).

Adjust the lever (1) correspondingly. Screw the positioner to the bracket (10) using three fixing screws.

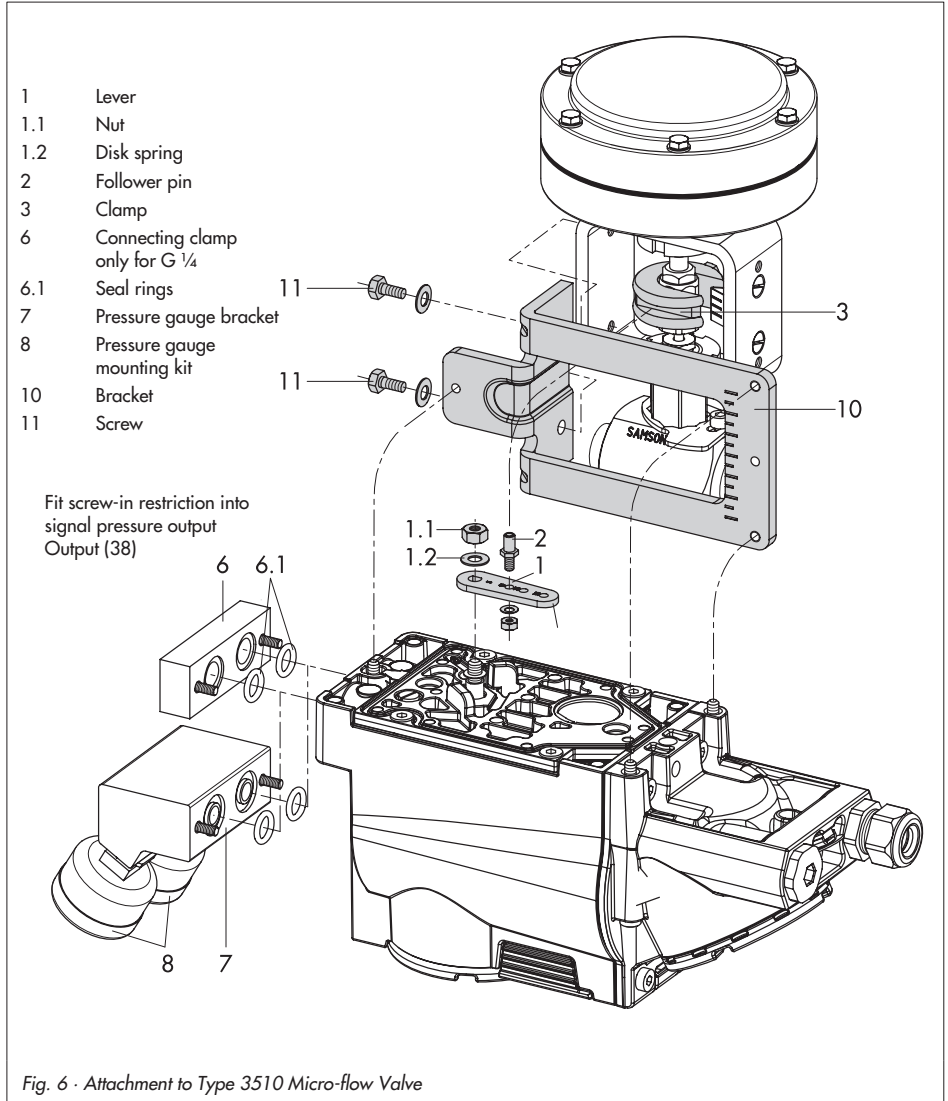

2.4 Attachment to rotary actuators

Refer to Table 5 on page 13 for the required mounting parts and the accessories with their order numbers as well as to the travel table on page 11.

Both mounting kits contain all the necessary mounting parts. The correct actuator size needs to be selected first.

Prepare actuator, and mount required adapter supplied by the actuator manufacturer, if necessary.

1. Mount the housing (10) onto the rotary actuator. In case of VDI/VDE attachment, place spacers (11) underneath, if necessary.
2. In case of SAMSON Type 3278 and VETEC S160 Rotary Actuator, screw the adapter (5) onto the free end of the shaft or place adapter (5.1) onto the shaft of the VETEC R Actuator.
3. Place adapter (3) onto Type 3278, VETEC S160 and VETEC R Actuator. For VDI/VDE version, this step depends on the actuator size.
4. Stick adhesive label (4.3) onto the coupling wheel in such a manner that the yellow part of the sticker is visible in the window of the housing when the valve is OPEN. Adhesive labels with explanatory symbols are enclosed and can be stuck on the housing, if required.
5. Screw tight coupling wheel (4) onto the slotted actuator shaft or adapter (3) using screw (4.1) and disk spring (4.2).

6. **Note!** Undo the standard follower pin (2) on the lever M (1) of the positioner. Attach the follower pin ($\varnothing 5$) included in the mounting kit to pin position 90° .
7. If applicable, mount pressure gauge bracket (7) with pressure gauges or, in case G $\frac{1}{4}$ threaded connections are required, the connecting plate (6), making sure both seal rings (6.1) are seated properly.

For double-acting, springless rotary actuators, a reversing amplifier is required to attach the positioner to the actuator. Refer to section 2.5.

Note! For actuators with a volume of less than 300 cm^3 , fit the screw-in restriction (Table 6) into the signal pressure output of the positioner (or the output of the pressure gauge bracket or connecting plate).

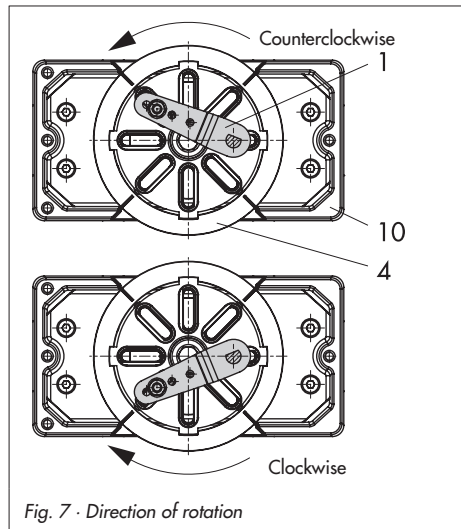

Fig. 7 · Direction of rotation

- 1 Lever
- 1.1 Nut
- 1.2 Disk spring
- 2 Follower pin
- 3 Adapter
- 4 Coupling wheel
- 4.1 Screw
- 4.2 Disk spring
- 4.3 Adhesive label
- 5 Actuator shaft or adapter
- 5.1 Adapter
- 6 Connecting plate (only for G 1/4)
- 6.1 Seal rings
- 7 Pressure gauge bracket
- 8 Pressure gauge mounting kit
- 10 Adapter housing
- 10.1 Screws
- 11 Spacers

Fit screw-in restriction into signal pressure output for actuators with <math>< 300 \text{ cm}^3</math> volume

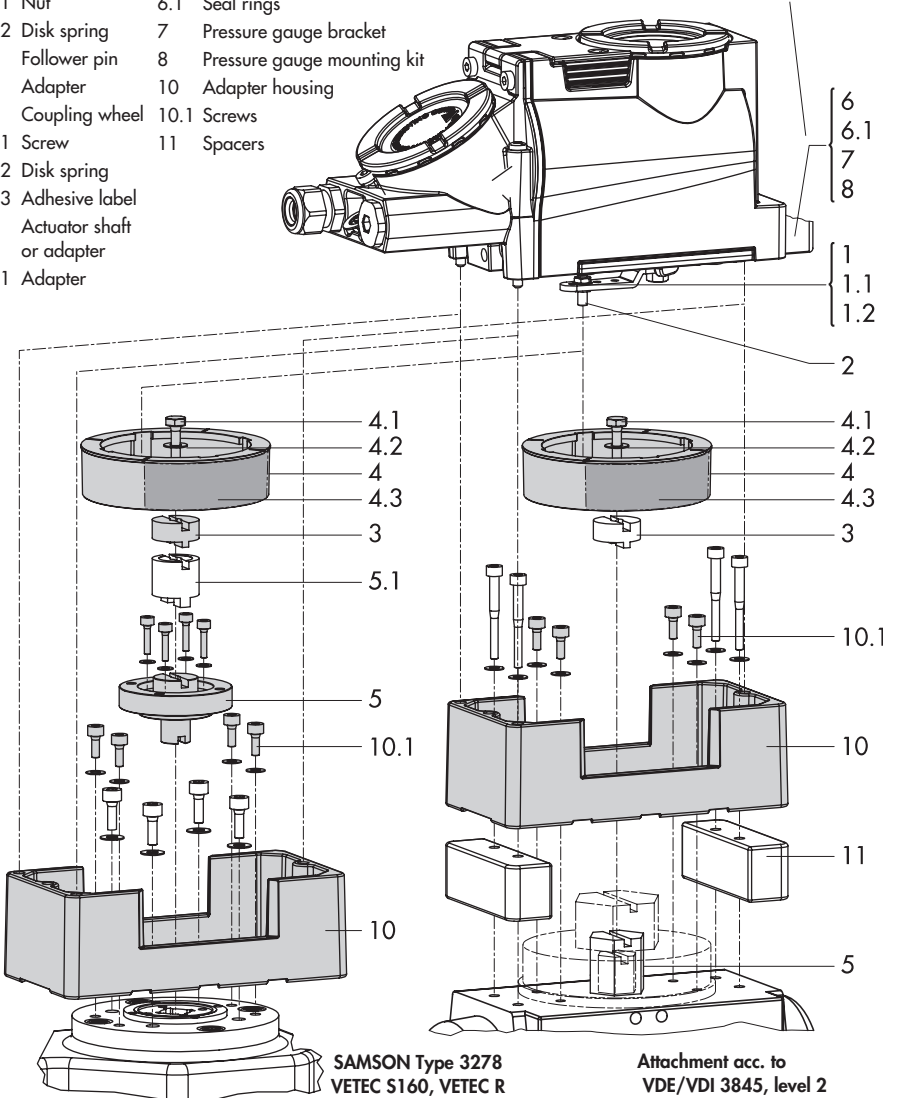

Fig. 8 · Attachment to rotary actuators

- Place positioner on the housing (10) and screw it tight. Considering the actuator's direction of rotation, align lever (1) so that it engages in the correct slot of the coupling wheel with its follower pin (Fig. 7).

2.5 Reversing amplifier for double-acting actuators

For the use with double-acting actuators, the positioner must be fitted with a reversing amplifier. The reversing amplifier is listed as an accessory in the Table 6 on page 13.

The output signal pressure of the positioner is supplied at the output **A₁** of the reversing amplifier. An opposing pressure, which equals the required supply pressure when added to the pressure at **A₁**, is applied at output **A₂**.

The rule **A₁ + A₂ = Z** applies.

Mounting

- Thread the special nuts (1.3) from the accessories of the reversing amplifier into the boreholes of the positioner. Remove the rubber seal (1.4).
- Insert the gasket (1.2) into the recess of the reversing amplifier and push both the hollowed special screws (1.1) into the connecting boreholes **A₁** and **Z**.
- Position the reversing amplifier and screw tight using both the special screws (1.1).
- Use a screwdriver (8 mm wide) to screw the enclosed filters (1.6) into the connecting boreholes **A₁** and **Z**.

Note!

*The sealing plug (1.5) in the Type 3731 Positioner should not be unscrewed out of the reversing amplifier.
The rubber seal (1.4) is not required and can be removed when the sealing plug is used.*

Signal pressure connections

A₁: Output **A₁** leading to the signal pressure connection at the actuator which opens the valve when the pressure increases

A₂: Output **A₂** leading to the signal pressure connection at the actuator which closes the valve when the pressure increases

On start up, always set the fail-safe position to AIR TO OPEN (**AIO**).

- After initialization has been performed, set pressure limit in Code **16** to **OFF**.

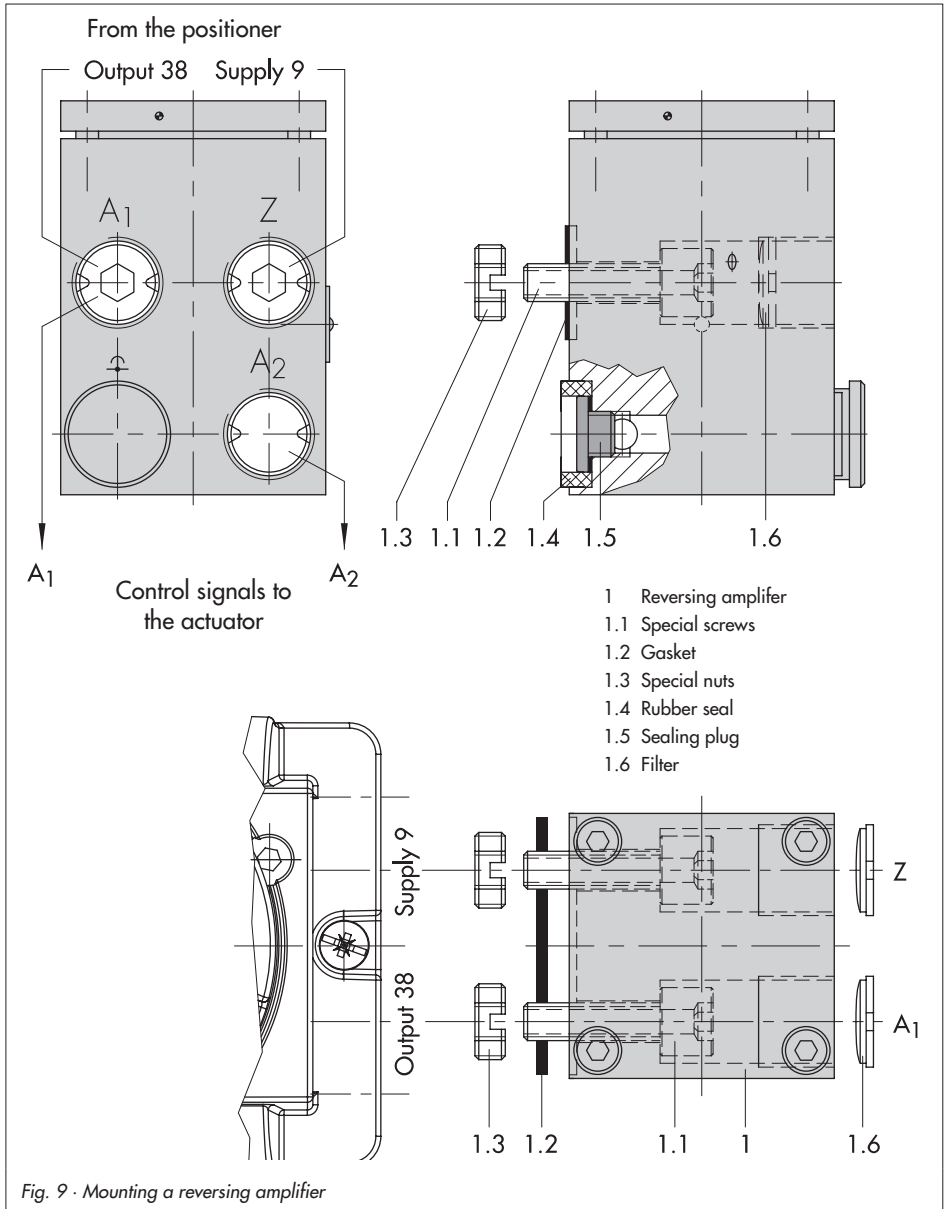

3 Connections

3.1 Pneumatic connections

Supply air

The inlet pressure of the supply air may not exceed 6 bar.

The operator of the apparatus must ensure that the operating medium cannot form an explosive atmosphere, i.e. only gases may be used which are free from substances whose presence in the medium might lead to the formation of an explosive atmosphere (including non-flammable gases, no oxygen or gases enriched with oxygen).

The positioner's threaded connections have $\frac{1}{4}$ NPT threads.

The cable glands can be directly screwed into the positioner when $\frac{1}{4}$ NPT threaded connections are used. In case G $\frac{1}{4}$ threaded connections are required, the cable glands are to be screwed into the required connecting plate (6) or pressure gauge mounting block or connection block available from the accessories. These accessories are designed with pneumatic connections with G $\frac{1}{4}$ threads. The customary fittings for metal and copper pipes or plastic hoses can be used.

Note!

The supply air must be dry and free from oil and dust. The maintenance instructions for upstream pressure reducing stations must be observed.

Blow through all air tubes and hoses thoroughly prior to connecting them.

If the positioner is attached directly to the Type 3277 Actuator, the connection of the positioner's output pressure to the actuator is fixed. For attachment according to IEC 60534-6 (NAMUR), the signal pressure can be routed to either the top or bottom diaphragm chamber of the actuator, depending on the actuator's fail-safe action "Actuator stem extends" or "Actuator stem retracts".

For rotary actuators, the manufacturer's specifications for connection apply.

3.1.1 Signal pressure gauges

To monitor the supply air (Supply) and signal pressure (Output), we recommend that pressure gauges be attached (see accessories in Tables 1 to 6).

3.1.2 Supply pressure

The required supply air pressure depends on the bench range and the actuator's operating direction (fail-safe action).

The bench range is registered on the nameplate either as spring range or signal pressure range depending on the actuator.

The direction of action is marked **FA** or **FE**, or by a symbol.

Actuator stem extends FA (Air to open AtO)

Fail-safe position "Valve Closed"
(for globe and angle valves):

Required supply pressure = Upper bench range value + 0.2 bar, minimum 1.4 bar.

Actuator stem retracts FE (Air to close AtC)

Fail-safe position "Valve Open"
(for globe and angle valves):

For tight-closing valves, the maximum signal pressure $p_{st_{max}}$ is roughly estimated as follows:

$$p_{st_{max}} = F + \frac{d^2 \cdot \pi \cdot \Delta p}{4 \cdot A} \text{ [bar]}$$

d = Seat diameter [cm]

Δp = Differential pressure across the valve
[bar]

A = Actuator diaphragm area [cm²]

F = Upper bench range of the actuator
[bar]

If there are no specifications, calculate as follows:

Required supply pressure =
Upper bench range value + 1 bar

Note!

The signal pressure at the output (Output 38) of the positioner can be limited to 1.4, 2.4 or 3.7 bar over Code 16 or the pressure limit can be deactivated.

3.2 Electrical connections



For electrical installation, you are required to observe the relevant electrotechnical regulations and the accident prevention regulations that apply in the country of use. In Germany, these are the VDE regulations and the accident prevention regulations of the employers' liability insurance association.

The following standards apply for assembly and installation in hazardous areas: EN 60079-14: 2003 (VDE 0165 Part 1/8.98) "Electrical apparatus for explosive gas atmospheres" and EN 50281-1-2: 1999 (VDE 0165 Part 2/11.99) "Electrical apparatus for use in the presence of combustible dust".

Connection to conform with the type of protection EEx d

The Type 3731 Positioner must be connected over the appropriate cable glands or conduit systems which meet the requirements of EN 60079-1: 2004 "Electrical apparatus for explosive gas atmospheres" - Part 1: Flameproof enclosures "d" Clauses 13.1 and 13.2 and for which a special test certificate is to hand.

Simple types of cable glands or blanking plugs may not be used.

Openings that are not used must be sealed as specified in Clause 11.9 of EN 50018: 2000. The connecting lead must be installed rigidly and protected adequately from being damaged.

In case the temperature exceeds 70 °C at the cable entries, appropriate temperature-resistant connecting leads must be used. The positioner must be integrated into the equipotential bonding system on site.

For the installation in the type of protection "Ex d", in particular the Clauses 9.4 and 10 of EN 60079-14: 2003 must be adhered to.

Connection to conform with the type of protection EEx e

Clause 11 of EN 60079-14: 2003 applies. On connecting cables to electrical apparatus with the type of protection "Increased safety" according to EN 60079-7: 2004 "Electrical apparatus for explosive gas atmospheres" - Part 7: Increased safety "e" cable glands must be used which are suitable for the type of cable being used. They must maintain the type of protection "e" and contain an appropriate sealing element to enable the required degree of protection (at least IP 54) of the connecting housing to be achieved and to meet the requirements concerning resistance to impact specified in EN 60079-0: 2004 "Electrical apparatus for explosive gas atmospheres" - Part 0: General requirements.

Devices used at ambient temperatures below -20 °C must have metal cable entries.

In cases where more than one cable core is connected to the same terminal, make sure that each cable core is clamped adequately. Two cables with varying cross-sections may only be connected to one terminal after being secured with a common crimp sleeve beforehand when it is not explicitly allowed in the documentation related to the electrical apparatus.

The threaded connections for the terminal compartment are designed as 1/2 NPT or M20x1.5 connections.

The electrical connections are intended to be connected to screw terminals for wire cross-sections of 0.2 to 2.5 mm² and a tightening torque of at least 0.5 Nm.

The wires for the reference variable are to be routed to the enclosure terminals marked **Signal** and are polarity insensitive. If the reference variable exceeds 20 mA, **OVERLOAD** appears on the LC display as an alarm.

Depending on the version, the positioner is equipped with an additional binary contact, a forced venting function or a position transmitter.

The position transmitter is operated in a two-wire circuit. The usual supply voltage is 24 V DC. Considering the resistance of the supply leads, the voltage at the position transmitter terminals can be between 11 V and 35 V DC at the maximum (reverse polarity protection, see Technical data).

Refer to Fig. 10 or the label on the terminal strip for terminal assignment.

Note!

The minimum permissible reference variable should not fall below 3.8 mA for operating the positioner.

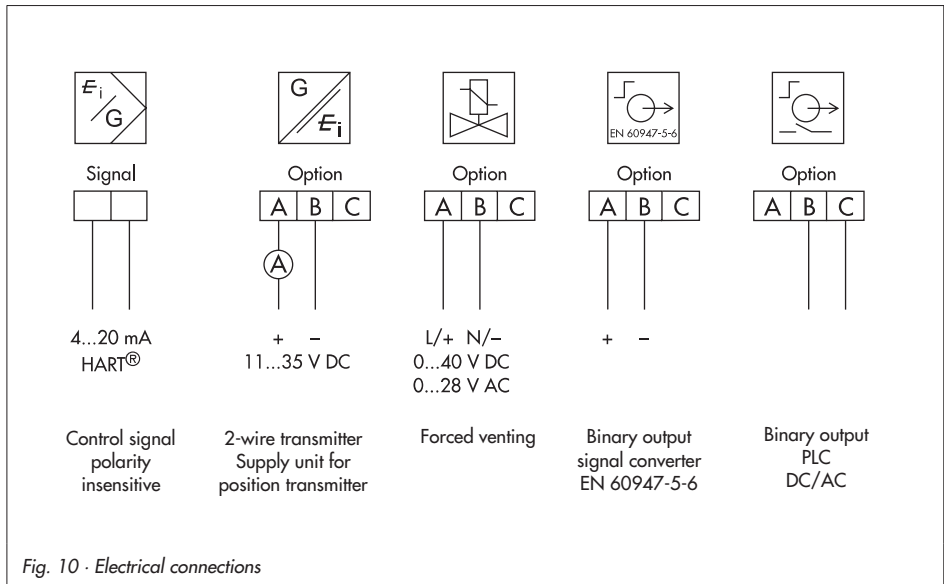

Fig. 10 · Electrical connections

3.2.1 Establishing communication

Communication between PC and the FSK modem or handheld communicator and positioner is based on the HART® protocol.

Type Viator FSK modem

RS 232 EExia Order no. 8812-0129

RS 232 not ex Order no. 8812-0130

USB not ex Order no. 8812-0132

If the load impedance of the controller or control station is too low, an isolation amplifier functioning as load converter is to be connected between controller and positioner.

By means of the HART® protocol, all control room and field devices connected in the loop are individually accessible through their address via point-to-point or standard bus (Multidrop).

Point-to-point:

The bus address/polling address must always be set to zero (0).

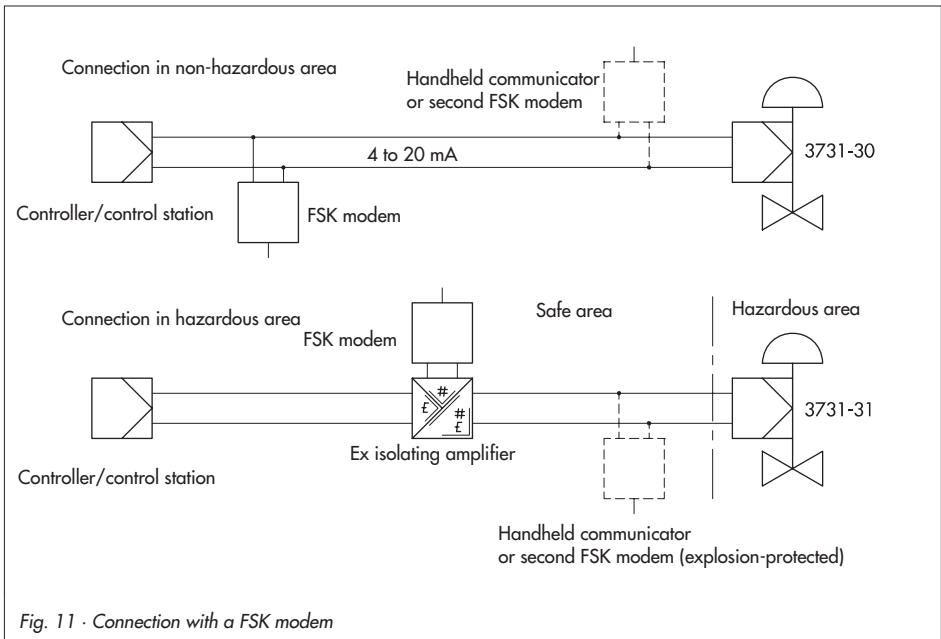

Fig. 11 · Connection with a FSK modem

Standard bus (Multidrop):

In the standard bus (Multidrop) mode, the positioner follows the analog current signal (reference variable) as for point-to-point communication. This operating mode is, for example, suitable for split-range operation of positioners (series connection). The bus address/polling address has to be within a range of 1 to 15.

Note!

Communication errors may occur when the process controller/control station output is not HART-compatible.

For adaptation, the Z box (order no. 1170-2374) can be installed between output and communication interface.

At the Z box a voltage of 330 mV is released (16.5Ω at 20 mA).

Alternatively, a $250\text{-}\Omega$ resistor can be connected in series and a $22\text{-}\mu\text{F}$ capacitor can be connected in parallel to the analog output. Note that in this case, the controller output load will increase.

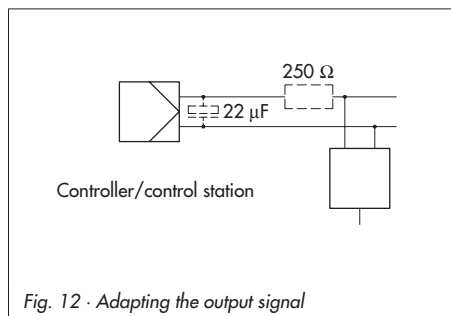

Fig. 12 · Adapting the output signal

4 Operation

The positioner is operated using the black rotary pushbutton which is only accessible after opening the screwed down protective cover on the front of the positioner.

Turn the pushbutton to select or set codes, parameters and values and press it to confirm them.

Symbols appear on the LC display that are assigned to parameters, codes, and functions.

The bar graph in the operating modes manual ↗ and automatic ↻ indicates the system deviation that depends on the sign (+/-) and the value. One bar graph element appears per 1 % system deviation.

If the device has not yet been initialized, the 1 symbol appears on the display and the lever position in degrees in relation to the longitudinal axis is indicated instead of the system deviation. One bar graph element corresponds to approximately a 5° angle of rotation.

If the fifth element blinks (value displayed > 30°), the permissible angle of rotation has been exceeded. Lever and pin position must be checked.

4.1 Enabling and selecting parameters

The codes which are marked with an asterisk (*) in section 9 on page 55 onwards must be enabled with Code 3 before the associated parameters can be configured as described below.



Code 3
Configuration
not enabled



Configuration
enabled

- ▶ From the current display, turn the button until Code **3** and **OFF** appear on the display. Confirm Code **3** by pressing the button, the code number blinks.
- ▶ Turn button until **ON** appears. Confirm setting by pressing the button.

Configuration is enabled and is indicated by ↗ symbol appearing on the display. Now you can adjust the codes, parameters and values for the control valve in any desired order by turning the button. Confirm settings by pressing the button.

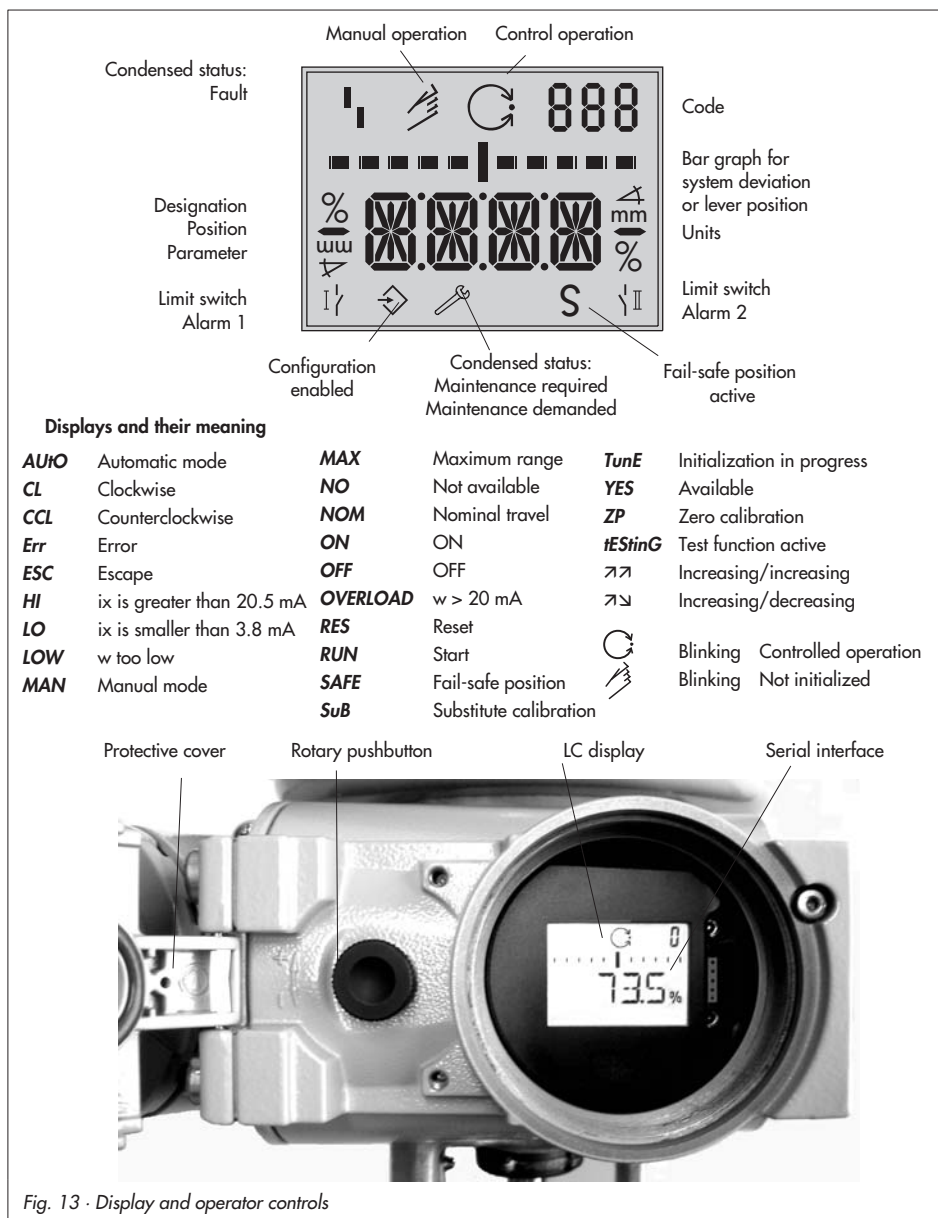

Fig. 13 · Display and operator controls

Note!

To cancel a value that you have just entered under a code, turn the button until **ESC** appears on the display and press to confirm.



Canceling the setting

Note! If no settings are entered within 120 seconds, the enabled configuration function becomes invalid and the display resets to Code **0**.

The code list on page 55 onwards in section 9 shows all parameters that can be adjusted, including their description and their default settings.

Important!

After attaching the positioner to the valve as well as setting the fail-safe position, it is sufficient for standard operation to start the initialization procedure (section 5.5 on page 39) in order to ensure optimum positioner operation.

For this purpose, the positioner must be operated with its default values. If necessary, a reset must be carried out (section 5.8 on page 49).

4.2 Operating modes

4.2.1 Automatic and manual operating modes

After initialization has been completed successfully for the first time, the positioner is automatically in  automatic operating mode.



Default

Switching to manual operating mode

Over Code **0**, press the button, **AUTO** appears in the display, Code **0** blinks.

Turn button until **MAN** appears.



Press button to switchover to the  manual operating mode.

The switchover is smooth since the manual operating mode starts up with the set point last used during automatic operating mode. The current position is displayed in %.

Adjusting the manual set point

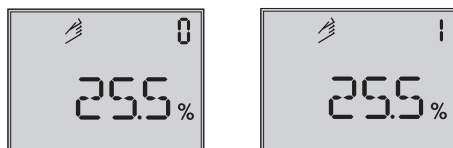

Turn button until Code **1** appears and press to confirm.

If Code **1** is blinking, the valve can be manually positioned by turning the button.

To proceed, turn the button until the positioner has built up enough pressure and the control valve starts to react.

The positioner automatically returns to manual mode with Code **0** if the button is not activated within two minutes.

Switching from manual to automatic operating mode:

Select Code **0** and return to automatic mode **AUTO** and confirm it by pressing the button.

4.2.2 SAFE – Fail-safe position

If you want to move the valve to fail-safe position, proceed as follows:

Select Code **0**, press the button, **AUTO** or **MAN** appears on the display, Code **0** blinks.

Turn the button until **SAFE** appears.



Press the button to confirm this setting.

*Operating mode **SAFE** has been selected, symbol **S** for the fail-safe position appears.*

Caution!

The valve moves to the fail-safe position.

Once the positioner is initialized, the current valve position is indicated on the digital display in %.

If you want to return the valve from the fail-safe position to the **AUTO** or **MAN** operating mode, the button must be pressed while Code **0** is active.

When the code number blinks, turn the button to switch to the desired operating mode. Press the button to confirm.

5 Start-up – Settings

- ▶ Undo fastening screws and flip open the protective cover on the enclosure.
- ▶ Connect pneumatic supply air (Supply 9), making sure the pressure is correct as described in section 3.1.
- ▶ Apply an electrical reference variable of 4 to 20 mA (terminals marked **Signal**).
- ▶ Connect the voltage supply for the version with forced venting as shown in Fig. 10.

When the positioner has not yet been initialized, **iESinG** runs across the display and then the **1** fault symbol appears and a hand symbol starts to blink on the display. The lever position in degrees in relation to the longitudinal axis is indicated as well.

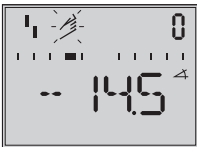

After setting the fail-safe position, it is sufficient for standard operation to start the initialization procedure (section 5.5 on page 39) in order to ensure optimum positioner operation.

5.1 Adapting the display

The data representation on the positioner display can be turned by 180°. If the displayed data appear upside down, proceed as follows:



Reading direction for right attachment of pneumatic connections

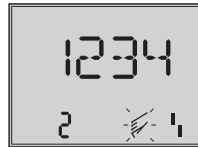

Reading direction for left attachment of pneumatic connections

Turn the button until Code **2** appears, and press the button to confirm Code **2**, Code **2** blinks.

Turn button until the display is adjusted to the desired direction, then confirm reading direction by pressing the button.

5.2 Limiting the signal pressure

If the maximum actuator force may cause damage to the valve, the signal pressure must be limited.

Select Code **3** to enable configuration and then access Code **16** to set the pressure limit to 1.4, 2.4 or 3.7 bar.

5.3 Checking the operating range of the positioner

To check the mechanical attachment and the proper functioning, the valve should be moved through the operating range of the positioner in the manual operating mode with the manual reference variable.



Code 0
Select
manual operating mode
Default **MAN**



Code 1
Position valve using the
button, the current angle of
rotation is indicated

1. Turn the button until Code **0** appears, then confirm Code **0** by pressing the button.
2. Turn the button until **MAN** appears in the display, i.e. manual operating mode, confirm selected operating mode by pressing the button.
3. Turn the button until Code **1** appears, confirm Code **1** by pressing button. The hand symbol and Code **1** blink.
4. Position control valve by turning the button several times until pressure builds up, and the control valve moves to its final positions so that the travel/angle of rotation can be checked.

The angle of the lever on the back of the positioner is displayed. A horizontal lever (mid-position) is equal to 0°. The permissible range has been exceeded

when the displayed angle is greater than 30°, and the outer right or left bar graph element blinks.

If this is the case, it is **absolutely necessary to check** lever and pin position as described in section 2.

Note!

*If the selected pin position is smaller than intended for the respective travel range, the positioner switches to the **SAFE** mode, the valve moves to the fail-safe position (see section 4.2.2 on page 35).*

5. Press the button to end manual operating mode.
6. Initialize positioner as described in section 5.5.

5.4 Determining the fail-safe position

To adapt the positioner to the operating direction of the actuator, the positioner must be set to AIR TO OPEN (**AiO**) or AIR TO CLOSE (**AiC**).

AIR TO OPEN = Signal pressure opens the valve, for fail-safe position: Valve CLOSED

AIR TO CLOSE = Signal pressure closes the valve, for fail-safe position: Valve OPEN

Double-acting actuators must always be set to AIR TO OPEN (**Ato**). Connect the pneumatic connections of the reversing amplifier as described in section 2.5.

Select Code **0** and press the button. **MAN** appears on the display.



Turn the button until **Init** appears

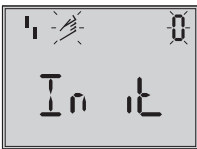

Press the button to confirm.

Turn the button to select the require fail-safe position.



Confirm the selected fail-safe position by pressing the button.

Turn the button until **ESC** appears on the display. Press the button to exit this menu point

or
start initialization as described in section 5.5 after setting the fail-safe position.

Simplified start-up!

For most applications, the positioner with its default settings is ready for operation, provided it has been properly attached. The positioner merely needs to be initialized after the fail-safe position has been set.

Caution!

Prior to starting the initialization procedure, check the maximum permissible supply pressure of the control valve to prevent the valve from being damaged. On initialization, the positioner supplies the maximum available supply pressure. If necessary, restrict the signal pressure by using a pressure reducing valve upstream of the control valve.

*Initialization is run in the default mode **MAX** (section 5.5.1). During this process, the positioner adapts itself optimally to the maximum travel/angle of rotation range.*

*The only parameter that must be checked is the direction of action, i.e. whether the default setting (Code **7**) matches the application or whether it must be changed.*

The initialization modes described in following serve to individually adapt and optimize the positioner to the way it is attached to the valve

5.5 Positioner initialization



During initialization the positioner adapts itself optimally to the friction conditions and the signal pressure demand of the control valve.

The type and extent of self-adaptation depends on the set initialization mode (see section 5.5.1).

MAX is the default mode setting for initialization based on the maximum nominal range.

If configuration is enabled via Code **3**, Code **6** can be used to change to other initialization modes.

If the positioner has been initialized once already, it will automatically go to the operating mode used last after the electrical reference variable is applied, Code **0** appears on the display.

If the positioner has not yet been initialized, the  fault symbol appears and the  hand symbol starts to blink on the display.

Note!

Every time you re-initialize the positioner, reset the positioner first to its basic setting including the default values. Refer to section 5.8 on page 49.

Starting the initialization process



Select Code **0** and press the button. **MAN** appears on the display.

Code **0** blinks.



Turn the button until **Init** appears

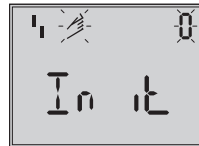

Press the button to confirm.

The set fail-safe position (section 5.4) appears.



Keep the button pressed down for at least **6 seconds!**



The bar graph on the display counts down and then the initialization process starts.

The time required for an initialization process depends on the transit time of the actuator and may take several minutes.

Positioners with **EXPERT+** diagnostic func-

tions start plotting the reference graphs after the initialization process has been completed. See note at the end of this section.



Warning!

During the initialization, the control valve moves through its entire travel/angle of rotation range. Therefore, do not start initialization while a process is running, but only during start-up, when all shut-off valves are closed.

Note!

*The initialization procedure can be interrupted while running by pressing the button. **STOP** appears three seconds long and the positioner then moves to the fail-safe position. The fail-safe position can be canceled again over Code 0.*

After a successful initialization, the positioner runs in control operation indicated by the  control symbol.

A malfunctioning leads to the process being interrupted. The initialization error appears on the display according to how it has been classified by the condensed status. See section 5.6 on page 48.

Note concerning EXPERT+:

Positioner with integrated EXPERT+ diagnostics automatically start to plot the reference graphs (drive signal y d1 and hysteresis d2) after initialization has been completed. TEST d1 and d2 appear on the display in an alternating sequence.

An unsuccessful plotting of the reference graphs is indicated on the display by Code 81 (see error code list).

After the initialization has been successfully completed, the positioner still works properly, even though the reference graph plotting has not been completed successfully. The reference graphs are required for the extended diagnostic functions of EXPERT+.

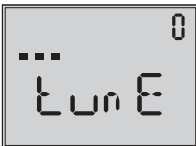

Alternating displays
Initialization running



Bar graph display
indicating the progress of
the initialization



Initialization successful,
positioner in automatic
operating mode

5.5.1 Initialization modes

After enabling configuration with Code 3 and accessing Code 6, you can choose one of the initialization modes **MAX**, **NOM**, **MAN** or **SUB** to start initialization. **ZP**, the zero calibration is described in section 5.7 on page 49.

MAX – Initialization based on maximum range

Initialization mode for simplified start-up for valves with two clearly defined mechanical travel stops, e.g. three-way valves. The positioner determines travel/angle of rotation of the closing member from the CLOSED position to the opposite side and adopts this travel/angle of rotation as the operating range from 0 to 100 %.

Enable configuration:



Default **OFF**

Turn button → Code **3**, press button,
turn button → **ON**, press button.

After configuration has been enabled:



Default **MAX**

Turn button → Code **6**,
press button,
turn button → **MAX**,
press button to confirm MAX mode setting.

Start initialization:

Turn button → Code **0**,
press button,
turn button → **Init**
press button. The set fail-safe position **A+O**
or **A+C** appears on the display.

Keep the button pressed down for at least 6 seconds! The initialization procedure starts.



The initialization procedure may take several minutes, depending on the actuator size. The valve moves through its entire travel/angle of rotation range.

Positioners with EXPERT+ diagnostic functions automatically start plotting the reference graphs after the initialization process has been completed. See the note on page 40.

Note!

For this **MAX** initialization mode, the positioner cannot indicate nominal travel/angle of rotation in mm/° at first, Code **5** remains disabled. In addition, the lower (Code **8**) and the upper (Code **9**) x-range value can only be displayed and modified in %.

If you want the display to indicate mm/°, proceed as follows after configuration has been enabled:

Turn button → Code **4**,
press button.

Turn button → Select pin position determined during installation and press button.

If you now switch to Code **5**, the nominal range appears in mm/°. The lower and upper x-range values for Code **8** and **9** are displayed in mm/° and can be adapted accordingly.

NOM – Initialization based on nominal range

Initialization mode for all globe valves.
For this initialization mode, pin position (Code 4), nominal travel/angle (Code 5) must be entered.

The calibrated sensor allows the effective valve travel to be set very accurately. During the initialization procedure, the positioner checks whether the control valve can move through the indicated nominal range (travel or angle) without collision.

In case of a positive result, the indicated nominal range is adopted with the limits of lower x-range and upper x-range values as the operating range.

Note!

The maximum possible travel must always be greater than the nominal travel entered. If this is not the case, the initialization is interrupted (error alarm Code 52) because the nominal travel is not achieved.

Enable configuration:



Default **OFF**

Turn button → Code **3**,
press button.
Turn button → **ON**,
press button.

After configuration has been enabled:



Default **OFF**

Turn button → Code **4**, press button,
turn button → Select pin position determined
during installation, press button.



Default **15**

Turn button → Code **5**, press button,
turn button → Enter nominal valve travel,
press button.



Default **MAX**

Turn button → Code **6**, press button,
turn button → **NOM**,
press button to confirm the NOM mode
setting.

Start initialization:

Turn button → Code **0**,
press button.
Turn button → **Init**,
press button. The set fail-safe position **AtO**
or **AtC** appears on the display.

Keep the button pressed down for at least 6 seconds! The initialization procedure starts.



The initialization procedure may take several minutes, depending on the actuator size. The valve moves through its entire travel/angle of rotation range.

Positioners with EXPERT+ diagnostic functions automatically start plotting the reference graphs after the initialization process has been completed. See note on page 40.

Check direction of action and, if necessary, set in Code 7.

MAN – Initialization based on a manually selected range

(with upper x-range value determined by means of manual adjustment).

Initialization mode same as **NOM**, however, for starting up valves with unknown nominal range.

In this mode, the positioner expects the control valve to be moved manually to the desired OPEN position prior to starting the initialization procedure.

The upper range travel/angle of rotation value is adjusted using the rotary pushbutton. The positioner uses this OPEN position and the CLOSED position to calculate the differential travel/angle and accepts it as the operating range with the lower x-range value and upper x-range value being the limits.



Default **MAN**

Turn button → Code **0**, press button.

Turn button → **MAN**, press button.



Turn button → Code **1**, press button, Code **1** blinks.

Turn button until the valve reaches its OPEN position, press button.

Enable configuration:



Default **OFF**

Turn button → Code **3**, press button, turn button → **ON**, press button.

After configuration has been enabled:

Turn button → Code **4**, press button, turn button → Select pin position determined during installation, press button.



Default **MAX**

Turn button → Code **6**, press button, turn button → **MAN**, press button to confirm the MAN mode setting.

Start initialization:

Turn button → Code **0**, press button.

Turn button → **Init**, press button.

The set fail-safe position **AtO** or **AtC** appears on the display.

Keep the button pressed down for at least 6 seconds! The initialization procedure starts.



The initialization procedure may take several minutes, depending on the actuator size. The valve moves through its entire travel/angle of rotation range.

Positioners with EXPERT+ diagnostic functions automatically start plotting the reference graphs after the initialization process has been completed. See note on page 40.

SUB

(substitute configuration, without initialization, without the valve moving through its range)

A complete initialization procedure takes several minutes and requires the valve to move through its entire travel range several times.

This mode allows a positioner to be replaced while the plant is running, with the least amount of disruption to the plant.

This initialization mode is an emergency mode. The positioner parameters are estimated and not determined by an initialization procedure, so that a high level of accuracy cannot be expected.

You should always select a different initialization mode if the plant allows it.

The initialization mode **SUB** is used to replace a positioner while the process is in operation. For this purpose, the control valve is usually fixed mechanically in a certain position, or pneumatically by means of a pres-

sure signal which is routed to the actuator externally. The blocking position ensures that the plant continues to operate with this valve position.

The spare positioner should not be initialized. If necessary, reset the spare positioner using Code **36**.

After the old positioner has been replaced with a new one, the following parameters must be entered: pin position (Code **4**), nominal range (Code **5**), direction of action (Code **7**) and closing direction (Code **34**). The default travel limit of 100 % (Code **11**) must be disabled with **OFF**.

In addition, the blocking position (Code **35**) must be adjusted with the button so that it matches the position of the previously blocked valve.

The parameters K_P (Code **17**), T_V (Code **18**) and the pressure limit (Code **16**) should remain set to their default values. If the configuration data of the new positioner are known, it is recommended to accept its K_P and T_V values.

After starting initialization, the positioner calculates its configuration data on the basis of the blocking position and the closing direction as well as the other entered data. The positioner switches to manual operation, subsequently the blocking position should be canceled as described on page 47.

Enable configuration:



Default **OFF**

Turn button → Code **3**,
press button,
turn button → **ON**, press button.

After configuration has been enabled:



Default **OFF**

Turn button → Code **4**, press button,
turn button → Select pin position determined
during installation, press button.



Default **15**

Turn button → Code **5**, press button,
turn button → Enter nominal valve travel,
press button.



Default **MAX**

Turn button → Code **6**, press button,
turn button → **Sub**, press button.

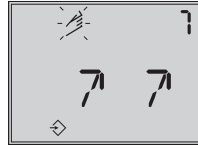

Default **↗↘**

Turn button → Code **7**, press button,

Turn button → Retain direction of action **↗↘**
or select **↗↘**

Press button.



Default **100.0**

Turn button → Code **11**,
press button,

Turn button until the travel limit is deacti-
vated when **OFF** appears on the display,
press button.

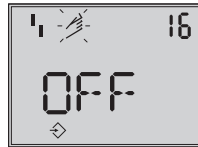

Default **OFF**

Turn button → Code **16**,

Retain default value for pressure limit,
change value only if necessary.

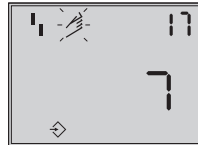

Default **7**

Turn button → Code **17**

Retain default value, change value only if necessary.

Turn button → Select Kp,
press button.

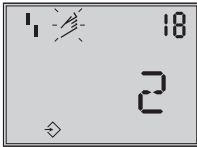

Default 2

Turn button → Code **18**,

Retain default value for Tv, change value only if necessary.



Default CCL

Turn button → Code **34**, press button,
turn button → Select closing direction.

CCL = counterclockwise and **CL** = clockwise.

Direction of rotation which causes the valve to move to the CLOSED position (view onto positioner display).

Press button.

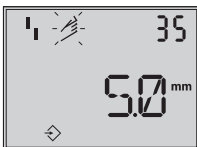

Default 0.0

Turn button → Code **35**, press button,

turn button → Enter blocking position, e.g. 5 mm (read off at travel indicator scale of the blocked valve or measure with a ruler).

Press button.

Start initialization:

Turn button → Code **0**,

press button,

Turn button → **Init**

press button. The set fail-safe position **AtO** or **AtC** appears on the display.

Keep the button pressed down for at least 6 seconds! The initialization procedure starts.

Operating mode changes to **MAN**

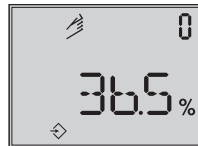

The adjusted blocking position is indicated

As initialization has not been carried out completely, the error code **76** (no emergency mode) and possibly also error code **57** may appear on the display.

These alarms do not influence the positioner's readiness for operation.

Canceling the blocking position

For the positioner to follow its reference variable again, the blocking position must be canceled and the positioner must be set to automatic operation **AUTO** as follows:

Turn button → Code **1**,
press button,
turn button in order to move the valve slightly past the blocking position, then cancel mechanical blocking.

Press button

Turn button → Code **0**,
press button, Code **0** blinks

Turn button until **AUTO** appears on the display.

Press button to confirm the operating mode.

The positioner switches to automatic operating mode!

The current valve position is indicated in %.

Note!

If the positioner shows a tendency to oscillate in automatic operating mode, the parameters K_P and T_V must be slightly corrected. Proceed as follows:

*Set T_V to 4 (Code **18**).*

*If the positioner still oscillates, the gain K_P (Code **17**) must be decreased until the positioner shows a stable behavior.*

Zero point correction

Finally, if process operations allow it, the zero point must be adjusted according to section 5.7 on page 49.

Caution!



The positioner automatically moves to zero point.

5.6 Fault/failure

All status and fault alarms are assigned a classified status in the positioner.

To provide a better overview, the classified alarms are summarized in a condensed status for the positioner (see section 6).

The condensed status appears on the display with the following symbols:

Condensed status	Display
Failure	
Maintenance required/ maintenance demanded	
Function check	Text
No alarm	

If the positioner has not been initialized, the fault symbol  appears on the display as the positioner cannot follow its reference variable.

The “Failure” condensed status causes the optimal fault alarm contact to be switched.

- ▶ The “Function check” condensed status can also switch the fault alarm contact in Code **32**.
- ▶ The “Maintenance required” condensed status can also switch the fault alarm contact in Code **33**.

To access the error codes, turn the button past the Code **50**.

Err appears on the display with the respective error code.

For the cause of the fault and its remedy, re-

fer to the codes listed in section 9 on page 55 onwards

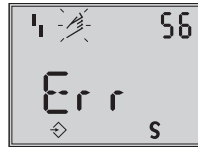

Display indicating an error code

After an error code has occurred, you should first try to confirm it as follows:

Enable configuration:

Turn button → Code **3**,
press button.

Turn button → **ON**, press button.

Turn button until the error code number appears, then press the button to confirm it.

Should the error occur again, read the remedy instructions in the error code list.

Occurrences such as when the total valve travel is exceeded or when the temperature leaves the permissible temperature range also affect the condensed state and cause a fault alarm to be displayed depending on its classification (see code list).

The optional EXPERT+ diagnostics generates additional diagnostic alarms which are included in the condensed status with their corresponding status classification.

When a diagnostic alarm is issued by EXPERT+ extended diagnostics, this is displayed by Code 79 (see error code list).

5.7 Zero calibration

In case of discrepancies with the closing position of the valve, e.g. with soft-sealed plugs, it may become necessary to recalibrate the zero point.

Enable configuration:



Default **OFF**

Turn button → Code **3**,
press button.

Turn button → **ON**, press button.

After configuration has been enabled:

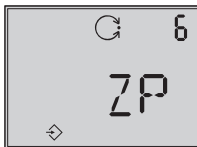

Default **MAX**

Turn button → Code **6**, press button.

Turn button → **ZP**, press button.

Turn button → Code **0**, press button,

turn button → **Init**, press button,

The set fail-safe position **AfO** or **AfC** appears on the display.

Keep the button pressed down for at least 6 seconds!

Zero calibration is started, the positioner moves the control valve to the CLOSED position and readjusts the internal electrical zero point.



The valve briefly moves from the current travel/angle of rotation position to the closed position.

5.8 Reset to default values

This function resets all parameters to the factory default values (see code list in section 9).

Enable configuration:



Default **OFF**

Turn button → Code **3**,
press button,

turn button → **ON**, press button.

After configuration has been enabled:



Default **OFF**

Turn button → Code **36**, press button,

turn button → **RUN**, press button.

All parameters are reset and can be reconfigured.

5.9 Start-up via local interface (SSP)

The positioner must be supplied with at least 4 mA current.

The positioner can be connected directly to the PC via the local serial interface and the serial interface adapter (order no. 1400-7700).

Use the TROVIS-VIEW software with 3731-3 device module installed which allows you to access all the device parameters.

For start-up and settings, proceed as described in section 5.

5.10 Start-up over HART® communication

The positioner must be supplied with at least 3.8 mA current. The FSK modem must be connected in parallel to the current loop.

A DTM file (Device Type Manager) conforming to the Specification 1.2 is available for communication. This allows the device, for example, to be run with the PACTware operator interface. All the positioner's parameters are then accessible over the DTM and the operator interface.

For start-up and settings, proceed as described in section 5.3 to 5.5.

Note!

The write access for HART communication can be disabled over Code 47. You can only disable or enable this function locally at the positioner.

The write access is enabled by default. The on-site operation including the INIT key can be locked over HART communication. The word "HART" then blinks on the display when Code 3 is selected. This locking function can only be disabled over HART communication. On-site operation is enabled by default.

6 Status and diagnostic alarms

The Type 3731-3 Positioner contains an integrated diagnostic approach to generate classified status and diagnostic alarms.

There are two different on-board diagnostics available: the standard integrated diagnostics (EXPERT) and the optional extended EXPERT+ diagnostics.

6.1 Standard EXPERT diagnostics

The standard EXPERT diagnostics provides information about positioner states such as operating hours counter, process monitoring, number of zero calibrations and initializations, total valve travel, temperature, initialization diagnostics, zero/control loop errors, logging of the last 30 alarms, etc.

The TROVIS-VIEW Operator Interface or a FDT frame application with DTM file provides an optimal visualization of information.

In addition, the standard EXPERT diagnostics generates diagnostic and status alarms which allow faults to be pinpointed quickly when a fault occurs.

Alarms are classified in the following main groups:

- ▶ Status
- ▶ Operation
- ▶ Hardware
- ▶ Initialization
- ▶ Data memory
- ▶ Temperature

6.2 Extended EXPERT+ diagnostics

In addition to the standard EXPERT diagnostic features, the optional EXPERT+ extended diagnostics provides the following online and offline test functions which enable significant statements on the condition of the entire control valve.

Online test functions (monitoring functions)

- ▶ Data logger
- ▶ Histogram
- ▶ Cycle counter
- ▶ Valve end position trend
- ▶ $y = f(X)$ diagram (drive signal)
- ▶ Hysteresis test

Offline test functions (manual functions)

- ▶ $y = f(X)$ diagram over the entire valve travel range
- ▶ Hysteresis test over the entire valve travel range
- ▶ Static characteristic curve
- ▶ Step response test

The diagnostic tests are completely integrated in the positioner. Further status alarms are generated from the extensive information gained in the diagnostic tests of EXPERT+ which provide the user with information covering the whole control valve. The required reference curves are automatically plotted after initialization and saved in the positioner if EXPERT+ is activated. The optional diagnostic functions provided by EXPERT+ can be selected when ordering

the positioner. Additionally, it is possible to activate EXPERT+ at a later point in time in an existing positioner.

For this purpose, an activation code can be ordered, specifying the serial number of the positioner.

6.3 Classification of the status alarms and the condensed status

The alarms are assigned a classification status in the positioner. The following states are differentiated between:

Failure

The positioner cannot perform its control task due to a functional fault in the device or in one of its peripherals or an initialization has not yet been successfully completed.

Maintenance required





The positioner still performs its control task (with restrictions). A maintenance requirement or above average wear has been determined. The wear tolerance will soon be exhausted or is reducing at a faster rate than expected. Maintenance is necessary in the medium term.

Maintenance demanded

The positioner still performs its control task (with restrictions). A maintenance demand or above average wear has been determined. The wear tolerance will soon be exhausted or is reducing at a faster rate than expected. Maintenance is necessary in the short term.

Function check

Test or calibration procedures are being performed. The positioner is temporarily unable to perform its control task until this procedure is completed.

Status alarm	Engineering tool
Alarm inactive	
Alarm active Classified as "No alarm"	
Alarm active Classified as "Maintenance required" / "Maintenance demanded"	
Alarm active Classified as "Function check"	
Alarm active Classified as "Failure"	

Classification process in the positioner

An alarm is assigned to one of following classified states in the table:

Condensed status

To provide a better overview, the state of the positioner is summarized in a condensed status which is made up from a summary of all classified positioner alarms.

If an event is classified as “No alarm”, this event does not have any affect on the condensed status of the positioner.

The condensed status is displayed in the engineering tool as well as on the positioner display as in the table belows:

Status modification

The classification of the status alarms can be changed as required. They can be modified using TROVIS-VIEW software over the local SSP interface.

In addition, the classification can be modified over the parameters in DD or easily entered over the DTM file.

Note!

All additional alarms generated by EXPERT⁺ have the status “No alarm” by default.







Logging and displaying diagnostic functions/alarms

The last 30 alarms are logged in the positioner. However, it is important to note that the same alarm is only logged once when it first occurs.

The alarms and the condensed states appear on the display as described in the code list (section 9).

In addition, the diagnostic parameters are issued over the communication interface of the positioner.

The diagnostic functions can easily be displayed and configured using the TROVIS-VIEW software connected over the local interface (SSP) or over the DTM file.

Status alarm	Engineering tool	Positioner display
“Failure”		
“Maintenance required” “Maintenance demanded”		
“Function check”		Text
“No alarm”		

7 Maintenance

The positioner does not require any maintenance.

There are filters with a 100 µm mesh size in the pneumatic connections for supply and output which can be removed and cleaned, if required.

The maintenance instructions of any upstream supply air pressure reducing stations must be observed.

8 Servicing explosion-protected devices

If a part of the positioner on which the explosion protection is based needs to be serviced, the positioner must not be put back into operation until an expert has inspected the device according to explosion protection requirements, has issued a certificate stating this or given the device a mark of conformity.

Inspection by an expert is not required if the manufacturer performs a routine test on the device prior to putting it back into operation. The passing of the routine test must be documented by attaching a mark of conformity to the device.

9 Code list

Code no.	Parameter – Display, values [default setting]	Description
Important! Codes with marked with an asterisk (*) must be enabled with Code 3 prior to configuration.		
0	Operating mode [MAN] AUtO SAFE ESC Init AtO AtC	AUtO = Automatic mode MAN = Manual mode SAFE = Fail-safe position ESC = Escape Switchover from automatic to manual mode is smooth. In fail-safe mode, the symbol S appears on the display. In MAN and AUtO mode, the system deviation is represented by the bar graph elements. When the positioner is initialized, the numerical display indicates the valve position or the angle of rotation in %, otherwise the position of the sensor in relation to the central axis is displayed in degrees °. Init = Start initialization for fail-safe position Air to open (AtO) or Air to close (AtC).
1	Manual w 0 to 100 [0] % of the nominal range	Adjust the manual set point with the rotary pushbutton, the current travel/angle is displayed in % when the positioner is initialized, otherwise the sensor position in relation to the central axis is indicated in degrees °. This can only be selected when Code 0 = MAN.
2	Reading direction [Normal] or upside down ESC	The reading direction of the display is turned by 180°.
3	Enable configuration [OFF] ON ESC	Enables modification of data that has been enabled (automatically deactivated when the rotary pushbutton has not been operated for 120 s.) HART blinks on the display when the on-site operation is locked. Codes marked with an asterisk (*) can only be read and not overwritten. Likewise, codes can only read over the SSP interface.

<p>4*</p>	<p>Pin position [OFF] 17, 25, 35, 50 mm 70, 100, 200 mm, 90° with rotary actuators ESC</p> <p>Note! If you select a pin position in Code 4 that is too small, the positioner switches to SAFE mode for reasons of safety</p>	<p>The follower pin must be inserted into the correct pin position according to the valve travel/angle of rotation. This pin position must be entered for initialization using NOM or Sub.</p> <table border="1"> <thead> <tr> <th>Pin position</th> <th>Standard</th> <th>Adjustment range</th> </tr> </thead> <tbody> <tr> <td>Code 4</td> <td>Code 5</td> <td>Code 5</td> </tr> <tr> <td>17</td> <td>7.5</td> <td>3.6 to 17.7</td> </tr> <tr> <td>25</td> <td>7.5</td> <td>5.0 to 25.0</td> </tr> <tr> <td>35</td> <td>15.0</td> <td>7.0 to 35.4</td> </tr> <tr> <td>50</td> <td>30.0</td> <td>10.0 to 50.0</td> </tr> <tr> <td>70</td> <td>40.0</td> <td>14.0 to 70.7</td> </tr> <tr> <td>100</td> <td>60.0</td> <td>20.0 to 100.0</td> </tr> <tr> <td>200</td> <td>120.0</td> <td>40.0 to 200.0</td> </tr> <tr> <td>90°</td> <td>90.0</td> <td>24.0 to 110.0</td> </tr> </tbody> </table>	Pin position	Standard	Adjustment range	Code 4	Code 5	Code 5	17	7.5	3.6 to 17.7	25	7.5	5.0 to 25.0	35	15.0	7.0 to 35.4	50	30.0	10.0 to 50.0	70	40.0	14.0 to 70.7	100	60.0	20.0 to 100.0	200	120.0	40.0 to 200.0	90°	90.0	24.0 to 110.0
Pin position	Standard	Adjustment range																														
Code 4	Code 5	Code 5																														
17	7.5	3.6 to 17.7																														
25	7.5	5.0 to 25.0																														
35	15.0	7.0 to 35.4																														
50	30.0	10.0 to 50.0																														
70	40.0	14.0 to 70.7																														
100	60.0	20.0 to 100.0																														
200	120.0	40.0 to 200.0																														
90°	90.0	24.0 to 110.0																														
<p>5*</p>	<p>Nominal range [15.0] mm or angle ° ESC</p>	<p>For initialization using NOM or Sub, the nominal travel/angle of rotation of the valve must be entered. The permissible adjustment range depends on the pin position according to the table.</p> <p>Code 5 is usually disabled whenever Code 4 is set to OFF. That means Code 5 can only be altered after entering a pin position.</p> <p>After initialization has been successfully completed, the maximum nominal travel/angle reached on initialization is displayed.</p>																														
<p>6*</p>	<p>Init mode [MAX] NOM MAN Sub ZP ESC</p>	<p>Select the initialization mode</p> <p>MAX: Maximum range of the control valve, the travel/angle of the closure member from the CLOSED position to the opposite stop in the actuator.</p> <p>NOM: Nominal range of the control valve, the travel/angle of the closure member measured from the CLOSED position to the indicated OPEN position.</p> <p>MAN: Manual adjustment: in Code 1</p> <p>SUB: No self-adjustment (emergency mode)</p> <p>ZP: Zero calibration</p>																														

7*	<p>w/x [↗↘] ↗↘ ESC</p>	<p>Direction of action of the reference variable w in relation to the travel/angle of rotation x (increasing/increasing or increasing/decreasing)</p> <p>Automatic adaptation: AIR TO OPEN: On completing initialization, the direction of action remains increasing/increasing (↗↗), a globe valve opens as the mA signal increases.</p> <p>AIR TO CLOSE: On completing initialization, the direction of action changes to increasing/decreasing (↗↘), a globe valve closes as the mA signal increases.</p>
8*	<p>Lower x-range value 0.0 to 80.0 [0.0] % of the nominal range, Specified in mm or angle ° provided Code 4 is set ESC</p>	<p>Lower range value for the travel/angle of rotation in the nominal or operating range.</p> <p>The operating range is the actual travel/angle of the control valve and is limited by the lower x-range value (Code 8) and the upper x-range value (Code 9).</p> <p>Usually, the operating range and the nominal range are identical. The nominal range can be limited to the operating range by the lower and upper x-range values.</p> <p>Value is displayed or must be entered.</p> <p>The characteristic is adapted. See also the example in Code 9!</p>
9*	<p>Upper x-range value 20.0 to 100.0 [100.0] % nominal range, Specified in mm or angle ° provided Code 4 is set ESC</p>	<p>Upper range value for the travel/angle of rotation in the nominal or operating range. Value is displayed or must be entered.</p> <p>The characteristic is adapted.</p> <p>Example: The operating range is modified, for example, to limit the range of a control valve which has been sized too large. For this function, the entire resolution range of the reference variable is converted to the new limits. 0 % on the display corresponds to the set lower limit and 100 % to the set upper limit.</p>
10*	<p>Lower x-limit [OFF] 0.0 to 49.9 % of the operating range ESC</p>	<p>Limitation of the travel/angle of rotation downwards to the entered value, the characteristic is not adapted.</p> <p>The characteristic is not adapted to the reduced range. See also example in Code 11.</p>

11*	Upper x-limit [100 %] 50.0 to 120.0 [100] % of the operating range or OFF ESC	Limitation of the travel/angle of rotation upwards to the entered value, the characteristic is not adapted. Example: In some applications, it may be a good idea to limit the valve travel, e.g. if a certain minimum medium flow rate is required or a maximum flow rate must not be reached. The lower limit must be adjusted with Code 10, and the upper limit with Code 11. If a tight-closing function has been set, it has priority over the travel limitation! When set to OFF, the valve can be opened past the nominal travel with a reference variable outside of the 4 to 20 mA range.
12*	w-start 0.0 to 75.0 [0.0] % of the reference variable range ESC	Lower range value of the applicable reference variable range must be smaller than the final value w-end, 0 % = 4 mA The reference variable range is the difference between w-end and w-start, and must be $\Delta w \geq 25\% = 4 \text{ mA}$. For an adjusted reference variable range of 0 to 100 % = 4 to 20 mA, the control valve must move through its entire operating range from 0 to 100 % travel/angle of rotation. In split-range operation , the valves operate with smaller reference variables. The control signal of the control unit to control two valves is divided such, for instance, that the valves move through their full travel/angle of rotation at only half the input signal (first valve set to 0 to 50 % = 4 to 12 mA and the second valve set to 50 to 100 % = 12 to 20 mA reference variable).
13*	w-end 25.0 to 100.0 [100.0] % of the reference variable range ESC	Upper range value of the applicable reference variable range, must be greater than w-start. 100 % = 20 mA
14*	Final position w < 0.0 to 49.9 [1.0] % of the span adjusted via Code 12/13 OFF ESC	If w approaches the final value up to the adjusted percentage that causes the valve to close, the actuator is immediately completely vented (with AIR TO OPEN) or filled with air (with AIR TO CLOSE). This action always lead to maximum tight-closing of the valve. Codes 14/15 have priority over Codes 8/9/10/11. Codes 21/22 have priority over Codes 14/15.

15*	Final position w > [OFF] 50.0 to 100.0 % of the span adjusted via Code 12/13 ESC	If w approaches the final value up to the adjusted percentage that causes the valve to open, the actuator is immediately completely filled with air (with AIR TO OPEN) or vented (with AIR TO CLOSE). This action always lead to the valve being completely opened. The pressure can be limited over Code 16. Codes 14/15 have priority over Codes 8/9/10/11. Codes 21/22 have priority over Codes 14/15. Example: Set the final position w > to 99 % for three-way valves.
16*	Pressure limit [OFF] P 1.4 2.4 3.7 bar ESC	The pressure limited determined on initialization is displayed in bar and can be altered. (Only with fail-safe position Valve Closed/AIR TO OPEN, for Valve Open/AIR TO CLOSE after initialization always set to [OFF], i.e. full supply pressure applied to actuator. The signal pressure can be limited already prior to initialization to prevent impermissibly high actuating forces). Note: After changing a pressure limit already set, the actuator must be vented once (e.g. by selecting the fail-safe position over Code 0). The pressure limit must always set to OFF after initialization for double-acting actuators.
17*	KP step 0 to 17 [7] ESC	Displaying or changing K_p Note on changing the K_p and T_V steps: During the initialization of the positioner, the K_p and T_V values are optimized. Should the positioner show a tendency for impermissibly high post-pulse oscillation due to additional interference, the K_p and T_V steps can be adapted after the initialization. For this, either the T_V step can be increased in increments until the desired response behavior is reached or, when the maximum value of 4 is reached, the K_p step can be decreased in increments. CAUTION! Changing the K_p step influences the system deviation.
18*	TV step [2] 1 2 3 4 OFF ESC	Displaying or changing T_V , See note under K_p step A change of the T_V step has no effect on the system deviation.

19*	Tolerance band 0.1 to 10.0 [5] % of the operating range ESC	Used for error monitoring Determination of the tolerance band in relation to the operating range. Associated lag time [30] s is a reset criterion. If a transit time is determined during initialization, which is 6 times > 30 s, the 6fold transit time is accepted as lag time.
20*	Characteristic 0 to 9 [0] ESC	Select the characteristic: 0: Linear 1: Equal percentage 2: Reverse equal percentage 3: Butterfly valve linear 4: Butterfly valve eq. percentage 5: Rotary plug valve linear 6: Rotary plug valve eq. perc. 7: Segmented ball valve linear 8: Segmented ball valve eq. p. 9: User-defined * * Definition over operator software
21*	w-ramp Open 0 to 240 s [0] ESC	The time required to pass through the operating range when the valve opens. Limitation of the transit time (Code 21 and 22): For some applications it is recommendable to limit the transit time of the actuator to prevent it from engaging too fast in the running process. Code 21 has priority over Code 15.
22*	w-ramp Closed 0 to 240 s [0] ESC	The time required to pass through the operating range when the valve closes. Code 22 has priority over Code 14.
23*	Total valve travel 0 to 9999 [0] subsequently 10E3-99E7 RES ESC	Totalled double valve travel. Can be reset to 0 via RES.
24*	LV total valve travel 1000 to 9999 [100 000] subsequently 10E3-99E7ESC	Limit value of total valve travel. If the limit value is exceeded, the fault symbol and the wrench symbol appear. Exponential display for 10 000 travel cycles onwards.

25*	Binary output [- / -] ESC	<p>This code allows you to find out on site whether the device has an optional binary output or not. When a binary output exists, its switching performance can be read and set. If there is no binary output, “- - -” appears on the display of the positioner.</p> <p>The binary contacts A1, A2 and the fault alarm can be configured at the output as follows:</p> <table border="1" data-bbox="465 427 1053 619"> <thead> <tr> <th>Alternating display</th> <th>Meaning</th> </tr> </thead> <tbody> <tr> <td>A1 -/ -</td> <td>A1 functioning as NO contact</td> </tr> <tr> <td>A1 ----</td> <td>A1 functioning as NC contact</td> </tr> <tr> <td>A2 -/ -</td> <td>A2 functioning as NO contact</td> </tr> <tr> <td>A2 ----</td> <td>A2 functioning as NC contact</td> </tr> <tr> <td>FAUL FAUL</td> <td>Fault alarm output (always NC contact)</td> </tr> </tbody> </table>	Alternating display	Meaning	A1 -/ -	A1 functioning as NO contact	A1 ----	A1 functioning as NC contact	A2 -/ -	A2 functioning as NO contact	A2 ----	A2 functioning as NC contact	FAUL FAUL	Fault alarm output (always NC contact)
Alternating display	Meaning													
A1 -/ -	A1 functioning as NO contact													
A1 ----	A1 functioning as NC contact													
A2 -/ -	A2 functioning as NO contact													
A2 ----	A2 functioning as NC contact													
FAUL FAUL	Fault alarm output (always NC contact)													
26*	Limit value A1 OFF 0.0 to 100.0 [2.0] % of the operating range ESC	Displaying or changing the software limit value A1 in relation to the operating range.												
27*	Limit value A2 OFF 0.0 to 100.0 [98.0] % of the operating range ESC	Displaying or changing the software limit value A2 in relation to the operating range.												
28*	Alarm test Reading direction: <table border="1" data-bbox="197 1018 454 1182"> <tr> <td>Standard</td> <td>Turned</td> </tr> <tr> <td>[OFF]</td> <td>[OFF]</td> </tr> <tr> <td>RUN 1</td> <td>1 RUN</td> </tr> <tr> <td>RUN 2</td> <td>2 RUN</td> </tr> <tr> <td>RUN 3</td> <td>3 RUN</td> </tr> <tr> <td>ESC</td> <td>ESC</td> </tr> </table>	Standard	Turned	[OFF]	[OFF]	RUN 1	1 RUN	RUN 2	2 RUN	RUN 3	3 RUN	ESC	ESC	<p>Testing the software limit switches alarm A1 and A2 as well as the fault alarm contact A3.</p> <p>If the test is activated, the respective limit switches five times.</p> <p>RUN1/1 RUN: Software limit switch A1 RUN2/2 RUN: Software limit switch A2 RUN3/3 RUN: Fault alarm contact A3</p>
Standard	Turned													
[OFF]	[OFF]													
RUN 1	1 RUN													
RUN 2	2 RUN													
RUN 3	3 RUN													
ESC	ESC													

29*	Position transmitter x/ix ³⁾ [↗↘] ↗↘ ESC	Operating direction of the position transmitter; indicates how the travel/angle position is assigned to the output signal i, based on the closed position. The operating range (see Code 8) of the valve is represented by the 4 to 20 mA signal. When a positioner is not connected (reference variable less than 3.6 mA), the signal is 0.9 mA and when the positioner has not been initialized 3.8 mA.
30*	Fault alarm ix ³⁾ [OFF] HI LO ESC	Used to select whether faults causing the fault alarm contact to switch should also be signaled by the position transmitter output and how they should be signaled HI ix = 21.6 mA or LO ix = 2.4 mA
31*	Position transmitter test ³⁾ -10.0 to 110.0 [50.0] % of the operating range ESC	Testing the position transmitter. Values can be entered in relation to the operating range.
³⁾ Analog position transmitter: Code 29/30/31 can only be selected if the position transmitter (optional) is installed.		
32*	"Function check" alarm NO [YES] ESC	The condensed status can be displayed as a fault alarm output over the optional binary contact (see Code 25). NO "Function check" condensed status has no affect on the fault alarm output YES "Function check" condensed status switches the fault alarm output
33*	"Maintenance required" alarm NO [YES] ESC	NO Only the "Failure" condensed status switches the fault alarm output, "Maintenance required", however, does not YES Both the "Failure" condensed status and "Maintenance required" condensed status switch the fault alarm output
34*	Closing direction CL [CCL] ESC	CL: Clockwise, CCL: Counterclockwise Turning direction of the lever for travel pick-up which moves the valve to the CLOSED position (view onto the positioner display). Needs only be entered in initialization mode SUB (Code 6).

35*	Blocking position [0] mm/° /% ESC	Entering the blocking position. Distance up to the CLOSED position. Only necessary in SUB initialization mode.
36*	Reset [OFF] RUN ESC	Resets all parameters to default (factory setting). Note: After setting RUN , the positioner must be re-initialized.
37	Position transmitter [NO] YES	Display only, indicates whether the position transmitter option is installed.
39	System deviation e info -99.9 to 999.9 % ,	Display only, indicates the deviation from the position required.
40	Transit time Open info 0 to 240 s [0]	Display only, minimum opening time is determined during initialization
41	Transit time Closed info 0 to 240 s [0]	Display only, minimum closing time is determined during initialization
42	Auto-w info 0.0 to 100.0 % of the span 4 to 20 mA	Display only, indicates the supplied automatic reference variable corresponding 4 to 20 mA.
43	Firmware info Xxxx	Display only, indicates the positioner type designation and the current firmware version of the positioner in alternating sequence.
44	y info 0 to 100 [0] %	Display only, blocked prior to initialization. After initialization: indicates the actuator pressure in %. 0 to 100 % corresponds to the pressure range which adjusts the travel/angle range from 0 to 100 %. If the actuator pressure is 0 bar, e.g. due to tight-closing on bottom or fail-safe action, OP appears on the display. If the actuator pressure is higher than the pressure required for x = 100 %, e.g. due to tight-closing on top, MAX appears on the display. Value is determined during initialization.

45	Forced venting info YES HIGH/LOW NO	Display only, indicates whether the forced venting option is installed. NO No forced venting function installed YES Forced venting installed If a voltage supply is connected at the terminals of the forced venting function, <i>YES</i> and <i>HIGH</i> appear on the display in alternating sequence. If a voltage supply is not connected (actuator vented, fail-safe position indicated on the display by the S symbol), <i>YES</i> and <i>LOW</i> appear on the display in alternating sequence.
46*	Polling address 0 to 63 [0] ESC	Select bus address 0 to 15 for active HART [®] Revision 5 (default setting) 0 to 63 for active HART [®] Revision 6. The address can only be switched over using the operating software.
47*	Write protection HART YES [NO] ESC	When the write protection function is activated, device data can only be read, but not overwritten over HART communication.

48	Diagnostics	
	d	Diagnostic parameters
	d0 Current temperature -55 to 125	Operating temperature [°C] inside the positioner (precision approx. 2.4 %)
	d1 Minimum temperature [20]	The lowest temperature below 20 °C that has ever occurred.
	d2 Maximum temperature [20]	The highest temperature above 20 °C that has ever occurred.
	d3 Number of zero calibrations [0]	The number of zero calibrations since the last initialization.
	d4 Number of initializations [0]	The number of initializations that have been performed.
	d5 Zero point limit [5 %] 0.0 to 100.0 %	Limit for the zero point monitoring.
	d6 Condensed status	Condensed status, made up from the individual states. OK: Okay, C: Maintenance required, CR: Maintenance demanded, B: Failure, I: Function check.
	d7 Start reference run [OFF] ON ESC	Triggering of a reference run for the functions: Drive signal y stationary and drive signal y hysteresis. The reference run can only be activated in manual operation as the valve moves through its entire travel range. If EXPERT ⁺ is activated at later point in time, the reference graphs must be plotted in order to activate the diagnostic functions.
	d8 EXPERT ⁺ activation	Enter the activation code for EXPERT ⁺ . After the activation procedure has been successfully completed, YES appears under d8.

Error codes – Remedy		Condensed status alarm active, when prompted, Err appears. If there are any fault alarms, they are displayed here.
Initialization error (indicated on the display by the condensed status with the corresponding classification)		
50	x < range	The value supplied by the measuring signal is either too high or too low, the measuring sensor is close to its mechanical limit. <ul style="list-style-type: none"> • Pin positioned incorrectly. • Bracket slipped in case of NAMUR attachment or positioner is not central. • Follower plate incorrectly attached.
	Remedy	Check attachment and pin position, set operating mode from SAFE to MAN and re-initialize the positioner.
51	$\Delta x > \text{range}$	The measuring span of the sensor is too low. <ul style="list-style-type: none"> • Pin positioned incorrectly. • Wrong lever. A rotational angle smaller than 11° at the positioner shaft creates just an alarm. An angle below 6° leads to the initialization being canceled.
	Remedy	Check attachment and re-initialize the positioner.
52	Attachment	<ul style="list-style-type: none"> • Positioner attachment incorrect. • Nominal travel/angle (Code 5) could not be achieved on initialization under NOM or SUB (no tolerance downwards permissible) • Mechanical or pneumatic error, e.g. wrong lever selected or supply pressure too low to move to the required position or pneumatic fault
	Remedy	Check attachment and supply pressure. Re-initialize the positioner. Under certain circumstances, it may be possible to check the maximum travel/angle by entering the actual pin position and then performing an initialization under MAX. After initialization has been completed, the Code 5 indicates the maximum achieved travel or angle.

53	Init time >	The initialization routine lasts too long. The positioner returns to its previous operating mode.
		<ul style="list-style-type: none"> • No pressure on the supply line or there is a leak. • Supply air failure during initialization.
	Remedy	Check attachment and supply pressure. Re-initialize the positioner.
54	Init – Forced venting	1) The forced venting option is installed (Code 45 = YES) and was not or not properly connected so that an actuator pressure could not be built up. The alarm appears even if you attempt to initialize the positioner.
		2) If you attempt to initialize the device from the fail-safe position (SAFE).
	Remedy	Re. 1) Check connection and supply voltage of the forced venting function. Re. 2) Set the MAN operating mode over Code 0. Then initialize the positioner.
55	Transit time <	The actuator transit times determined during the initialization are so short that the positioner cannot adapt itself optimally.
		Remedy
56	Pin pos.	Initialization was canceled because you are required to enter the pin position for the selected initialization modes NOM and SUB .
		Remedy
Operational error (indicated on the display by the condensed status with the corresponding classification)		
57	Control loop Additional alarm at the fault alarm contact!	Control loop error, the control valve does not react within the tolerable times of the controlled variable (tolerance band alarm Code 19).
		<ul style="list-style-type: none"> • Actuator mechanically blocked. • Attachment of the positioner subsequently postponed. • Supply pressure not sufficient.
	Remedy	Check attachment.

58	Zero point	Zero point incorrect. Error may arise when the mounting position/linkage of the positioner moves or when the valve seat trim is worn, especially with soft-sealed plugs.
	Remedy	Check valve and mounting of the positioner. If OK, perform a zero calibration over Code 6 (see section 5.7 on page 49).
59	Autocorrection	Should an error occur in the data range of the positioner, the self-monitoring function recognizes it and automatically corrects it.
	Remedy	Automatic
60	Fatal error	An error was detected in the data relevant for safety, autocorrection is not possible. This may be due to EMC disturbances. The control valve moves to its fail-safe position.
	Additional alarm at the fault alarm contact! Remedy	Reset over Code 36. Re-initialize the positioner.
Hardware error (indicated on the display by the condensed status with the corresponding classification)		
62	x signal	Determination of the measured value for the actuator has failed. Conductive plastic element is defective. The positioner continues to run in emergency mode, but should be replaced as soon as possible. The emergency mode on the display is indicated by a blinking control symbol and 4 dashes instead of the position being displayed.
	Additional alarm at the fault alarm contact! Remedy	Note on the control: If the measuring system has failed, the positioner is still in a reliable state. The positioner switches to emergency mode where the position cannot be accurately controlled anymore. However, the positioner continues operation according to its reference variable signal so that the process remains in a safe state. Return the positioner to SAMSON AG for repair.

63	w too small	The reference variable is much smaller than 4 mA (0 %); occurs if the power source that drives the positioner does not comply with the standard. This state is indicated on the positioner display by a blinking LOW . The positioner moves to the fail-safe position SAFE .
	Remedy	Check reference variable. If necessary, limit the current source downwards so that no values below 4 mA can be issued.
64	i/p converter (y)	The circuit of the i/p converter has been interrupted. The positioner moves to the fail-safe position SAFE .
	Remedy	Cannot be remedied. Return the positioner to SAMSON AG for repair.
Error appendix		
65	Hardware Additional alarm at the fault alarm contact!	A hardware error has occurred, the positioner moves to the fail-safe position SAFE .
	Remedy	Confirm error and return to the automatic operating mode, or perform a reset and re-initialize the device. If this is not successful, return device to SAMSON AG for repair.
66	Data memory Additional alarm at the fault alarm contact!	The writing of data to the data memory does not work anymore, e.g. when the written data deviate from the read data. Valve moves to the fail-safe position.
	Remedy	Return the positioner to SAMSON AG for repair.
67	Test calculation Additional alarm at the fault alarm contact!	The hardware positioner is monitored by means of a test calculation.
	Remedy	Confirm error. If this is not possible, return the positioner to SAMSON AG for repair.

Data error		
68	Control parameter Additional alarm at the fault alarm contact!	Control parameter error, e.g. due to EMC disturbances.
	Remedy	Confirm error, perform reset and re-initialize the positioner.
69	Poti parameter Additional alarm at the fault alarm contact!	Parameter error of the digital potentiometer.
	Remedy	Confirm error, perform reset and re-initialize the positioner.
70	Calibration Additional alarm at the fault alarm contact!	Error in the production calibration data, e.g. due to EMC disturbances. Subsequently, the device runs on default values
	Remedy	Return the positioner to SAMSON AG for repair.
71	General parameters	Parameter errors that are not critical for the control.
	Remedy	Confirm error. Check and, if necessary, reset required parameters.
72	Start-up parameters	Start-up parameter errors
	Remedy	Confirm error, perform reset and re-initialize the positioner.
73	Internal device error 1	Internal device error
	Remedy	Return the positioner to SAMSON AG for repair.
74	HART® parameters	Error in the HART® parameters that are not critical for the control function.
	Remedy	Confirm error. Check and, if necessary, reset required parameters.
75	Info parameters	Error in the info parameters that are not critical for the control function.
	Remedy	Confirm error. Check and, if necessary, reset required parameters.

76	No emergency mode	The travel measuring system of the positioner has a self-monitoring function (see Code 62). A controlled emergency mode is not available on certain actuators, such as double-acting actuators. For this reason, the positioner moves to the fail-safe position when a measuring error occurs. During the initialization, the positioner checks whether the actuator has such a function or not.
	Remedy	Merely information, confirm, if necessary. No further action necessary.
77	Program loading error	When the device starts operation for the first time after the input signal has been applied, it carries out a self-test (<i>tEstinG</i> runs across the display). If the device loads a program that does not correspond to that of the positioner, the valve moves to the fail-safe position. It is not possible to make the valve leave this fail-safe position again by operating the positioner.
	Remedy	Interrupt current and restart positioner. Otherwise, return the positioner to SAMSON AG for repair.
78	Options parameter	Errors in options parameters, e.g. due to EMC disturbances.
	Remedy	Return the positioner to SAMSON AG for repair.
79	Diagnostic alarms	Alarms are generated in the EXPERT ⁺ extended diagnostics if EXPERT ⁺ has been successfully activated in Code 48.
80	Diagnostic parameters	Error which is not critical for control.
	Remedy	Confirm error. Check and, if necessary, start new reference run.
81	Reference graphs	Error on plotting the reference graphs of drive signal y stationary or drive signal y hysteresis. <ul style="list-style-type: none"> • Reference run was interrupted • Reference line y stationary or y hysteresis was not adopted.
	Remedy	Confirm error. Check and, if necessary, start new reference run.

10 Setting with TROVIS-VIEW software – Parameter list

10.1 General

A CD-ROM containing the program for installing the TROVIS-VIEW Configuration and Operator Interface is provided by SAMSON.

The system requirements are specified in the **readme.txt** file in the root directory of the CD-ROM.

Insert the installation CD-ROM to start the installation program. Once inserted, the CD-ROM usually starts the installation program automatically depending on the configuration of the operating system.

If the program does not start automatically, double-click **setup.exe** in the root directory of the CD-ROM in order to install TROVIS-VIEW.

Follow the on-screen prompts and instructions of the installation program.

The TROVIS-VIEW Operator Interface can be used for different SAMSON devices. Note that the installation program also offers you the option of installing a demo module. To use the software without restrictions, the software needs to be activated as described as follows:

After installation, a dialog box will appear, prompting you to enter the CD key, which you will find on the cover of the original CD-ROM. Once you have entered the correct CD key and initiated the activation process, a request code will be automatically generated. The *Activation* dialog box will come up displaying the generated request code and an Internet link to SAMSON's activation server where a unique activation code will then be generated and displayed. Enter this activation code into TROVIS-VIEW's *Activation* dialog box. The software is now ready for use without any restrictions in the purchased scope.

To enable communication with the PC, connect the serial interface to the serial interface (5-pole jack) of the positioner using a SAMSON connecting cable with serial interface adapter (order no. 1400-7700). The positioner must be supplied with a 4 to 20 mA reference variable.

The positioner settings configured in TROVIS-VIEW can be directly transferred over the SAMSON connecting cable to the positioner on site. This online connection enables you to read any entered settings as well as providing a diagnostic function.

10.2 Starting TROVIS-VIEW and performing basic settings

Settings may be entered into the TROVIS-VIEW operator interface when either the positioner is connected or not connected. When the positioner is connected, the data uploaded from the positioner can be overwritten.

When the positioner is not connected, the default settings appear on the operator interface display or, alternatively, a stored TROVIS-VIEW file (*.tro) can be loaded and written over in the *File* menu by selecting *Open*.

Connection to the positioner is established by clicking the symbols on top right on the device toolbar:



Upload data from the positioner and display them in the operator interface



Download data onto the positioner from the operator interface



The positioner is in online mode, indicated by the TROVIS-VIEW 3 logo on the top right in the blue bar. Data in the window presently open are updated cyclically (uploaded and downloaded again).



The positioner is in offline mode.

You can also activate the listed functions in the *Device* menu as follows.

```
Device    > Upload
          > Download
          > Online mode
```

1. Start TROVIS-VIEW.



Make required settings in *View* menu by activating or deactivating functions.

When the Trend Viewer is activated, all operating data are uploaded cyclically from the positioner in online mode and shown in the form of graphs.

Right-click on the graph to edit the graph format or to copy the logged data to a file.

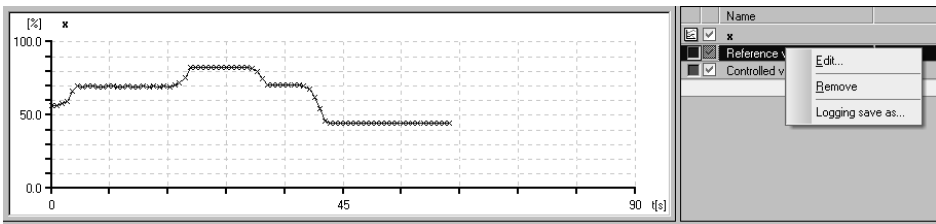

2. Select required language in *Options* menu.

The selected language can be changed at any time except in online mode.

3. Select *Communication* from the *Options* menu and choose communication settings.

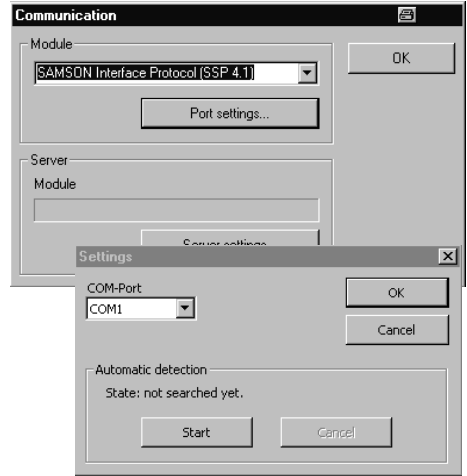

4. Click on *Port settings* and select port as well as server setting.

5. Select *Convert* in the *File* menu to select the firmware version of the positioner. It must match the version specified in the bar at the top.

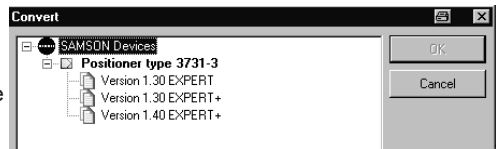

6. Enter more details about the plant, if necessary, in *Customer Data* in the *Edit* menu.

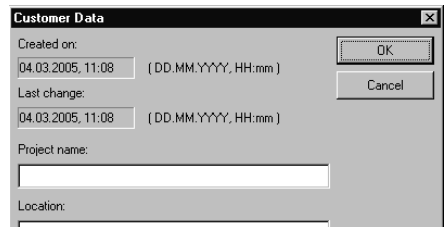

7. Select *Load Factory Defaults* in *Edit* menu to upload default settings to the operator interface.

10.3 Setting the parameters

Click on one of the folders listed in the left column to open a window listing the settings of the corresponding parameters. Place the mouse arrow on the parameter name to open a tool tip providing information about that particular parameter.

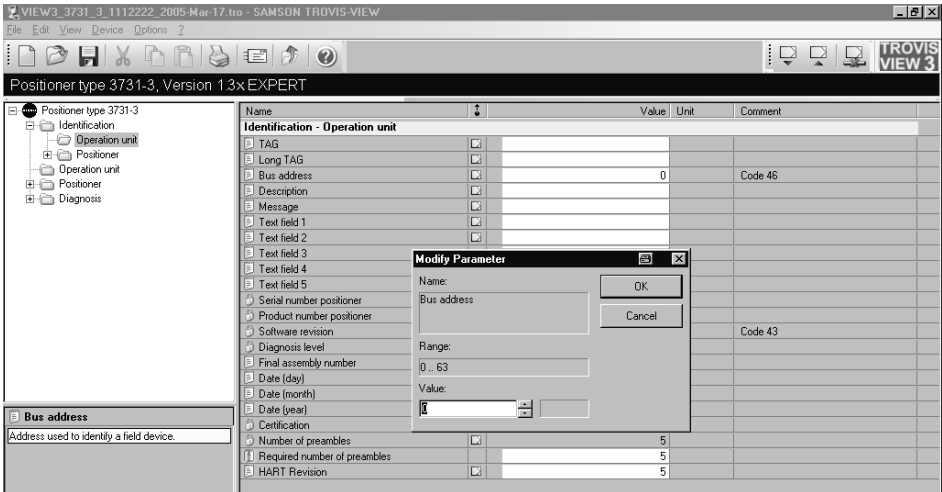

Double-click on a parameter to open a window to enable the parameter to be modified.

Right-click on the parameter to open a drop-down menu providing further editing options.

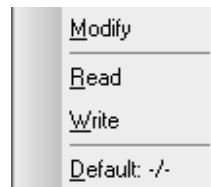

The parameters in all the folders are listed in the following parameter list.







11 Parameter list

Parameter	Values	Default setting	Description Refer to section 9 for the description of codes
Identification – Operation unit			
TAG	Max. 8 characters		Tag identification of operation unit
Long TAG	Max. 32 characters		
Bus address	0...63	0	Code 46
Description	Max. 16 characters		Freely available text fields
Message	Max. 32 characters		
Text field 1 to 5	Max. 32 characters		
Positioner serial number			Serial number of the positioner
Positioner product number		3731-3 xxx	Manufacturer model number of the positioner
Firmware version		x.xx	Current firmware version of device, Code 43
Diagnosis level	EXPERT EXPERT ⁺	EXPERT	
Final assembly number	0...16777215	0	Any number assignable to clearly identify the entire field device
Date (day)	1...31	1	Date that can be entered. Stored in the positioner
Date (month)	January ...Dec	January	
Date (year)	1900...2155	2005	
Certification			Indicates whether the positioner can be used in hazardous area
Number of preambles		5	Number of required synchronization bytes
Required number of preambles	5...20	5	
HART revision		5	Designates the version of the HART specification which is supported by the positioner

Parameter list

Identification – Positioner			
Device type		3731-3	Indicates exact model designation
Identification – Positioner – Actuator			
Type identification actuator			Manufacturer ID number of the actuator that the positioner is mounted upon
Actuator type	Single-acting Double-acting	Single-acting	Actuator with or without spring return mechanism
Attachment	Integral/ NAMUR	Integral	Defines the attachment of the positioner on the control valve
Booster	Not present/ present	Not present	Pneumatic volume booster
Actuator size	60...5600	240 cm ²	Effective diaphragm or piston area of the actuator
Signal pressure lower value	0.0...6	0.2 bar	Initial value of the actuator bench range
Signal pressure upper value	0.0...6	1.0 bar	Final value of the actuator bench range
Supply pressure	0.0...6	6.0 bar	Supply pressure of compressed air network
Identification – Positioner – Valve			
Type identification valve			Manufacturer ID number of the valve that the positioner is mounted upon
Direction of flow	Flow-to-open (FTO)/ Flow-to-close (FTC)	Flow-to-open (FTO)	Indicates in which direction the process medium flows to the valve plug.
Packing	Adjustable/ Self-adjusting/ Bellows seal	Self-adjusting	Sealing of the plug stem to the atmosphere
Seating surface (leakage class)	Metal sealing/ Lapped-in metal/ Soft sealing/ Nickel sealing	Metal sealing	Type of sealing between seat and plug
Pressure balancing	Without/ With (PTFE)/ With (graphite)	Without	Plug with pressure balancing to compensate for forces

Flow characteristic	Linear 30:1/ Eq. perc. 30:1/ Linear 50:1/ Eq. perc. 50:1/ Other	Linear 50:1	Valve characteristic: Flow to valve travel
Valve dimensions standard	DIN/ANSI	DIN	Valve dimensions according to DIN or ANSI
Nominal size DN	8...2100	50	Nominal size in mm (DIN) or inch (ANSI)
Kvs coefficient	0.0001... 20000.0000	1.0000 Kv	Valve flow coefficient
Kvs unit	Kv/cv	Kv	Flow coefficient, metric unit (Kvs) or US American units (cv)
Seat diameter of the valve	2.0...500.0	6.0 mm	Diameter of valve seat bore
Identification – Positioner – Additional components			
Forced venting		Not installed	Code 45
Position transmitter			Code 37
Inductive limit switch			Code 38
Operation unit			
HART® write protection		Not write protected	Code 47
Start with default settings			Code 36
Positioner – Operating mode			
Current operating mode			Indicated the current operating mode used by the device
Target operating mode	Automatic/ Manual/Fail-safe position	Automatic	Code 0
Positioner – Process data			
Reference variable w	Displays current process variables		Code 42
Controlled variable x			Current position
System deviation e			Deviation from target position (e=w-x)
Manipulated variable			Indicates the actuator pressure after the initialization has been completed

Status		
Condensed state		<p>Summarized state of the positioner. The condensed status is made up from the various states. The condensed status can take on the following states:</p> <p>No alarm </p> <p>Maintenance required </p> <p>Maintenance demanded </p> <p>Failure </p> <p>Function check </p> <p>The condensed states "Maintenance required" and "Maintenance demanded" are also indicated on the positioner display by . The "Failure" condensed status causes the  fault alarm symbol to appear on the display.</p>
Fault exists (fault alarm contact)	Display and alarm	Status of the fault alarm contact
Status of limit switch A1		Status of the switching output for limit switch A1
x falls below A1		Indicates whether the controlled variable x has fallen below the limit for A1
Status of limit switch A2		Status of the switching output for limit switch A2
x exceeds A2		Indicates whether the controlled variable x has exceeded the limit for A2
Operational status		Indicates the current operational status of the internal control
Temperature		Current temperature in the positioner

Positioner – Reference variable			
Direction of action	Increasing/ increasing >> Incr./decr. <>	Increasing/ increasing >>	Code 7
Lower reference range value	0.0...75.0 %	0.0 %	Code 12
Upper reference range value	25.0...100.0 %	100.0 %	Code 13
Enable final position smaller than w	On/Off	On	Code 14
Final position when w is smaller	0.0...49.9 %	1.0 %	Code 14
Enable final position greater than w	On/Off	Off	Code 15
Final position when w is greater	50.0...100.0 %	100.0 %	Code 15
Required transit time OPEN	0...240 s	0 s	Code 21
Required transit time CLOSED	0...240 s	0 s	Code 22
Positioner – Working range			
Initial value of travel range/angle of rotation range	0.0...12.0 mm	0.0 %	Code 8
Final value of travel range/angle of rotation range	3.0...15.0 mm	100.0 %	Code 9
Enable travel/angle of rotation lower limit	On/Off	Off	Code 10
Travel/angle of rotation lower limit	0.0...49.9 %	0.0 %	Code 10
Enable travel/angle of rotation upper limit	On/Off	On	Code 11
Travel/angle of rotation upper limit	50.0...120.0 %	100.0 %	Code 11

Example for user-defined characteristic



- Select **User defined characteristic** in *Characteristic selection* parameter.
- Double-click on **Edit, open or save characteristic** to open a window where the characteristic can be edited.
Click on *Characteristic* button on the bottom right to open and save a characteristic.
- Click on OK button to download the characteristic onto the positioner.

Positioner type 3731-3, Version 1.3xEXPERT

Characteristic

x: Reference variable [Xn] (%)
y: Travel / angle [Yn] (%)

No.	x[%]	y[%]
1	0.0	0.0
2	17.7	10.5
3	31.4	18.4
4	50.2	30.9
5	65.5	43.8
6	72.6	50.7
7	78.7	58.2
8	90.6	75.7
9	93.5	81.3
10	96.1	87.9
11	100.0	100.0

File name: <User defined>

OK
Cancel

Characteristic...
Open...
Save
Save As...

Parameter list

Parameter	Values	Default	Description
Positioner – Performance characteristics			
Required proportional-action coefficient KP (step)	0...17	7	Code 17
Proportional-action coefficient KP (step)			Code 17
Required derivative-action time TV (step)	Off/1/2/3/4	2	Code 18
Derivative-action time TV (step)			Code 18
Positioner – Fail-safe action			
Fail-safe position		Closing	Fail-safe action of the actuator upon air/auxiliary power failure or device start-up. Determined on initialization (see section 5.4). In double-acting actuators, the fail-safe position relates only to the failure of the auxiliary power supply. There is no defined position when the supply air fails.
Positioner – Error control			
Tolerance band	0.1...10.0 %	5.0 %	Code 19
Delay time	0...9999 s	30 s	Reset criterion for running control loop monitoring. A control loop error is issued when the delay time is exceeded and the system deviation is not within the tolerance band.
Total valve travel		1	Code 23
Limit of the total valve travel	1000... 990 000 000	1 000 000	Code 24
Enable limit value A1	On/Off	On	Code 26
Limit value A1	0.0...100.0 %	2.0 %	Code 26
Enable limit value A2	On/Off	On	Code 27
Limit value A2	0.0...100.0 %	98.0 %	Code 27
“Function check” condensed status	Yes/No	No	Code 32

"Maintenance required" condensed status	Yes/No	Yes	Code 33
Zero point limit	0.0...100.0 %	5.0 %	Limit for zero point monitoring







Positioner – Error control – Classification report

Condensed status fault alarms

Note!

Each fault alarm has a status assigned to it.

The possible states are placed in order starting with the lowest priority:



No alarm		Alarm is not added to the condensed status
Maintenance required		Lowest  Highest priority
Maintenance demanded		
Failure		
Function check		

The fault alarm present in the device with the highest priority determines which condensed status is displayed.

The condensed states "Maintenance required" and "Maintenance demanded" are also displayed on the positioner display by .

The condensed status "Failure" causes the  fault alarm symbol to appear on the display.

Parameter list

x > range	Determines the individual status for each alarm	Code 50
Delta x < range		Code 51
Attachment		Code 52
Initialization time exceeded		Code 53
Initialization/ solenoid valve		Code 54
Transit time not achieved		Code 55
Pin position		Code 56
Control loop		Code 57
Zero point		Code 58
Autocorrection		Code 59
x signal	with symbol  an alarm is not added to the condensed status	Code 62
w too small		Code 63
Control parameter		Code 68
Poti parameter		Code 69
Calibration parameter		Code 70
General parameters		Code 71
Internal device error 1		Code 73
HART parameter		Code 74
Parameter info		Code 75
No emergency mode		Code 76
Options parameter	Symbol  for maintenance required and maintenance demanded	Code 66
Total valve travel exceeded		Code 67
Temperature < -40 °C		Code 72
Temperature > 80 °C		Code 78
	or symbol  for function check	Determines the condensed status when a fault occurs
		Temperature fell below -40 °C during operation
		Temperature exceeded +80 °C during operation

Positioner – Start-up			
Reading direction	Pneumatic connection right/left	Pneumatic connection right	Code 2
Pin position	Off 17/25/35/50/ 70/100/200 mm 90°	Off	Code 4
Initialization mode	Nominal range Maximum range Manual adjustment Substitution	Maximum range	Code 6
Pressure limit	Off /1.4 / 2.4 /3.7 bar	Off	Code 16
Determined nominal range			Code 5
Minimum transit time OPEN			Code 40
Minimum transit time CLOSED			Code 41
Fail-safe action			Fail-safe action of the actuator upon air/auxiliary power failure or device start-up. Determined during initialization. In double-acting actuators, the fail-safe position relates only to the failure of the auxiliary power supply. There is no defined position when the supply air fails.
Positioner – Start-up – Initialization			
Initialization mode	Nominal range Maximum range Manual adjustment Substitution	Maximum range	Code 6
Device initialized			Status of device initialization
Initialization			Starting of initialization procedure. The initialization mode parameter must be first set to the required initialization procedure.
Initialization status			Status of the running initialization procedure

Parameter list

Initialization canceled			Running initialization procedure has been canceled. The control valve moves to its fail-safe position.
Target operating mode	Automatic Manual SAFE	Automatic	Code 0
Current operating mode			Indicates current operating mode of positioner
Initialization error			
x > range	Alarm		Code 50
Delta x < range			Code 51
Attachment			Code 52
Initialization time exceeded			Code 53
Initialization/ solenoid valve			Code 54
Transit time too short			Code 55
Pin position			Code 56
No emergency mode			Code 76
Positioner – Start-up – Substitution			
Initialized in Sub mode			Indicates whether the substitute configuration (sub mode) has been performed
Closing direction		Counter-clockwise	Code 34
Blocking position		0.0 %	Code 35
Positioner – Maintenance			
Start zero calibration			
Zero calibration			Starts zero calibration
Initialization status			Status of running initialization procedure
Initialization canceled			Running initialization procedure has been canceled. The valve moves to fail-safe position.
Target operating mode	Automatic Manual SAFE	Automatic	Code 0
Current operating mode			Indicates current operating mode of positioner

Positioner – Simulation			
Alarm test A1			Code 28
Alarm test A2			Code 28
Alarm test A3 (alarm fault output)			Code 28
Diagnosis			
Diagnosis level setting		EXPERT	
Current operating mode		Automatic	Indicates current operating mode of positioner
Diagnosis – Status alarms			
Status			
Condensed status	Alarm symbol		Summarized condensed status. Made up from various states.
Operating hours counter	Display or status		Time elapsed since first initialization
Device in closed loop			Time elapsed in closed loop since first initialization
Device switched on since last initialization			Time elapsed since last initialization
Device in closed loop since last initialization			Time elapsed in closed loop since last initialization
Error occurred (fault alarm output)			Status of fault alarm output
Solenoid valve status			Status of optional solenoid valve
Fail-safe position			Fail-safe action of actuator upon air supply/auxiliary power failure or device start-up. Determined during initialization.
Device initialized			Status of device initialization
Start performed with default settings			Indicates whether a start has been performed with default settings.
Local operation active			Local operation is active
Configuration changed			Status of device status bit configuration changed.

Parameter list

Number of zero calibrations		Number of zero calibrations performed since last initialization
Number of initializations		Number of initializations performed
Zero point limit		Limit for zero point monitoring
Operation		
Control loop	Alarm	Code 57
Zero point		Code 58
Autocorrection		Code 59
Fatal error		Code 60
w too small		Code 63
Total valve travel exceeded		Status of total valve travel limit
Temperature exceeded		Status alarm resulting from diagnosis analysis
Hardware		
x-signal	Alarm	Code 62
i/p converter		Code 64
Hardware		Code 65
Data memory		Code 66
Control calculation		Code 67
Program load error		Code 77
Initialization		
x range	Alarm	Code 50
Delta x < range		Code 51
Attachment		Code 52
Initialization time exceeded		Code 53
Initialization/solenoid valve		Code 54
Transit time too short		Code 55
Pin position		Code 56
No emergency mode		Code 76

Data memory		
Control parameter	Alarm	Code 68
Poti parameter		Code 69
Calibration parameter		Code 70
General parameters		Code 71
Internal device error 1		Code 73
HART parameter		Code 74
Info parameter		Code 75
Option parameter		Code 78
Diagnostic parameters		Code 80
Temperature		
Min. temperature	Display	Lowest temperature recorded in the positioner
Max. temperature		Highest temperature recorded in the positioner
Min. temperature (time)		Operating hours counter logging when the lowest temperature was recorded in the positioner
Max. temperature (time)		Operating hours counter logging when the highest temperature was recorded in the positioner
Diagnosis – Status messages – Data logger		
Alarms (1) to (30)	Alarm	Recorded alarms issued by the positioner
Operating hours since first initialization		Operating hours counter logging of each alarm
Diagnosis – Status alarms – Reset		
Reset absolute total travel	Resetting corresponding alarms	Reset counter for absolute total valve travel back to 0
Reset default values flag		Set back default values flag to 0
Reset configuration changed		Reset device status bit configuration changed.

Parameter list

Reset initialization error		
Reset x > range	Resetting corresponding alarms	Code 50
Reset Delta x < range		Code 51
Reset attachment		Code 52
Reset initialization exceeded		Code 53
Reset initialization/solenoid valve		Code 54
Reset transit time too short		Code 55
Reset pin position		Code 56
Reset operational error		
Reset zero point	Resetting corresponding alarms	Code 58
Reset autocorrection		Code 59
Reset hardware error		
Reset hardware	Resetting corresponding alarms	Code 65
Reset control calculation		Code 67
Reset data error		
Reset control parameter	Resetting corresponding alarms	Code 68
Reset poti parameter		Code 69
Reset general parameters		Code 71
HART parameter		Code 74
Reset options parameter		Code 78
Reset diagnostic parameters		Code 80
Reset statistical information		
Reset data logger		Measured data in the data logger buffer memory are deleted

12 Dimensions in mm

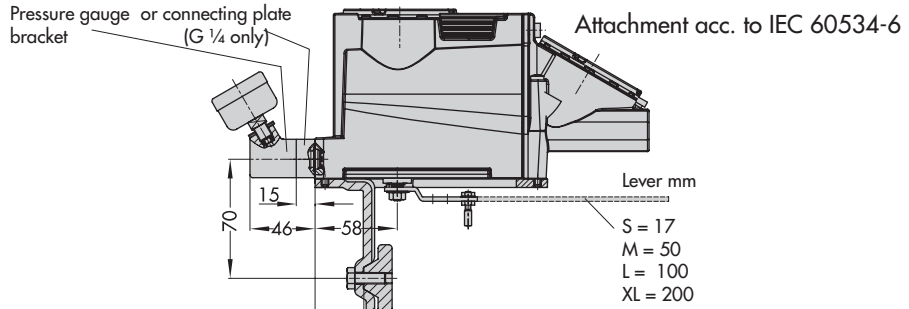

Direct attachment → 34

Electrical connections:
 2x female threads
 1/2 NPT or
 M20x1.5

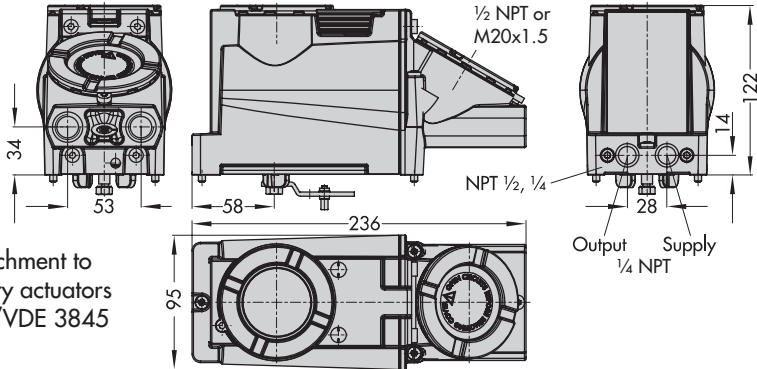

for all sizes of fixing level 2

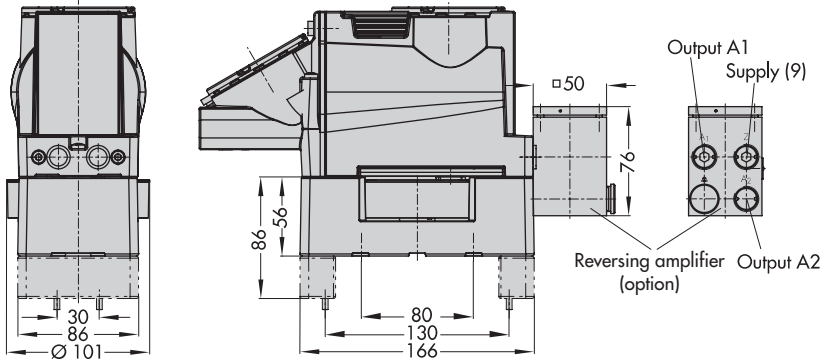



TRANSLATION

EC TYPE EXAMINATION CERTIFICATION

(1) **EC Type Examination Certificate Number**

(2) **Equipment and Protective Systems Intended for Use in Potentially Explosive Atmospheres – Directive 94/9/EC**

(3) **EC Type Examination Certificate Number**

PTB 05 ATEX 1058

(4) **Equipment:** Model 3731-321, Electropneumatic Positioner

(5) **Manufacturer:** SAMSON AG, Mess- und Regeltechnik

(6) **Address:** Weismüllerstr. 3, D-60314 Frankfurt, Germany

(7) The equipment and any acceptable variations thereof are specified in the schedule to this certificate.

(8) The Physikalisch-Technische Bundesanstalt, notified body number 0102, in accordance with Article 9 of the Council Directive 94/9/EC of 23 March 1994, certifies that this equipment has been found to comply with the Essential Health and Safety Requirements relating to the design and construction of equipment and protective systems intended for use in potentially explosive atmospheres as specified in Annex II to the Directive.

The examination and test results are recorded in confidential report
PTB Ex-OS-13010.

(9) The Essential Health and Safety Requirements are satisfied by compliance with
EN 50014:1997+A1+A2 EN 50018:2000 + A1 EN 50019:2000
EN 50281-1-1:1998 + A1

(10) If the sign "X" is placed after the certificate number, it indicates that the equipment is subject to special conditions for safe use specified in the schedule to this certificate.

EC Type Examination Certificates without signature and seal are invalid.
This EC Type Examination Certificate may only be reproduced in whole or in part without any changes, schedule included.
Changes or omissions will require the prior approval of the Physikalisch-Technische Bundesanstalt.

Physikalisch-Technische Bundesanstalt, Bundesallee 100, D-38116 Braunschweig
PTB-50-3731.doc



(11) This EC Type Examination Certificate relates only to the design and examination of the specified equipment in compliance with Directive 94/9/EC. Further requirements of this Directive apply to the manufacture and supply of this equipment. These requirements are not covered by this Certificate.

(12) The marking of the equipment shall include the following:

II 2G EEx d IIC T6, T5 or T4 or EEx de IIC T6, T5 or T4

II 2D IP 65 T 80 °C

Zertifizierungsstelle Explosionschutz Braunschweig, 19 July 2005
By order

(Signature) (Seal)

Dr. Ing. W. Theodens

EC Type Examination Certificates without signature and seal are invalid.
This EC Type Examination Certificate may only be reproduced in whole or in part without any changes, schedule included.
Changes or omissions will require the prior approval of the Physikalisch-Technische Bundesanstalt.

Physikalisch-Technische Bundesanstalt, Bundesallee 100, D-38116 Braunschweig
PTB-50-3731.doc

S c h e d u l e

- (13) (14) (15) **EC TYPE EXAMINATION CERTIFICATE No. PTB 05 ATEX 1 0558**

Description of Equipment

The Model 3731-321 Electro pneumatic Positioner is a single- or double acting positioner with communication capability intended for attachment to any current linear or rotary actuator. The positioner compares the control signal of 4 to 20 mA from a control system with the travel of the control valve and supplies a pneumatic pressure signal, configuration and parameterization of the positioner are achieved by means of the HART protocol via the signal line for the 4 to 20 mA signal. Data transmission is achieved by a superposed frequency on the 4 to 20 mA signal lines.

Technical Data

Supply voltage: 10 to 35 V DC
Signal circuit: 4 to 20 mA
Power dissipation: max. 7.5 W

(16) Test Report: **PTB-Ex-05-13010**

Special conditions for safe use

None

Additional notes on safe operation

Connection requirements for the terminal compartment version with type of protection "flameproof enclosure"

- The Model 3731-321 Electro pneumatic Positioner shall be connected via suitable cable entries or conduit systems satisfying the requirements of En 50018 Clause 13.1 and 13.2 and for which a separate certificate has been issued.
- Cable entries (Pg glands) and simple closing plugs must not be used.
- Apertures not used shall be closed in compliance with En 50018 Class 11.,9.
- The connecting cable of the Model 3731-321 Electro pneumatic Positioner shall be installed rigidly and in such a manner that it is protected adequately from mechanical damage.
- If the temperature at the entry facilities exceeds 70 °C, adequately temperature-resistance connecting leads shall be used.

EC Type Examination Certificates without signature and seal are invalid
The EC Type Examination Certificate may only be reproduced in its entirety and without any changes, shades included
Edits and changes will require the prior approval of the Physikalisch-Technische Bundesanstalt.

Physikalisch-Technische Bundesanstalt, Bundesallee 100, D-38116 Braunschweig
PTB50-3731.doc

6. The model 3731-321 Electro pneumatic Positioner shall be included in the local equal-potential bonding system.

These notes shall be attached to each unit in a suitable form.

Ambient temperature

The Model 3731-321 Electro pneumatic Positioner is intended for use in temperature class T6 with ambient temperatures from -40 °C to + 60 °C temperature class T5 with ambient temperatures from -40 °C to +70 °C temperature class T4 with ambient temperatures from -40 °C to +80 °C

Pneumatic working medium

- The maximum supply pressure is 6 bar.
- The user of the apparatus shall ensure that the working medium cannot form an explosive atmosphere, i. e. only gases may be used that are free of substances the existence of which could result in an explosive atmosphere (non-combustible gases and no oxygen or gases enriched with oxygen).

(18) Basic Health and Safety Requirements

Satisfied by compliance with the standards specified above

Braunschweig, 19 July 2005

Zertifizierungsstelle Explosionschutz

By order

(Signature) (seal)

Dr. Ing. M. Theden

EC Type Examination Certificates without signature and seal are invalid
The EC Type Examination Certificate may only be reproduced in its entirety and without any changes, shades included
Edits and changes will require the prior approval of the Physikalisch-Technische Bundesanstalt.

Physikalisch-Technische Bundesanstalt, Bundesallee 100, D-38116 Braunschweig
PTB50-3731.doc



SAMSON AG · MESS- UND REGELTECHNIK
Weismüllerstraße 3 · 60314 Frankfurt am Main · Germany
Phone: +49 69 4009-0 · Fax: +49 69 4009-1507
Internet: <http://www.samson.de>

EB 8387-3 EN

S/Z 2006-02